

Easy Cove wall wash

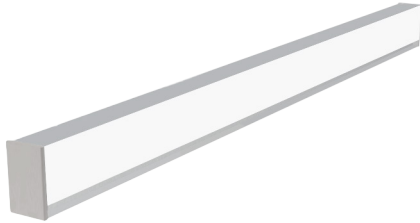

Our Easy Cove luminaires are designed for quick, simple installation in custom or pre-fabricated architectural coves.

Features

- Aluminum core LED boards
- Quick Connectors for continuous butt-mounting
- Specifiable color temperature. CRI > 90, R9 > 50
- Custom patterns and finishes available
- Integral, specifiable dimmable drivers or PoE
- 5 Year, 50,000 hour warranty, damp location rated
- WELL Building Standard compatible [learn more](#)

Dimensions

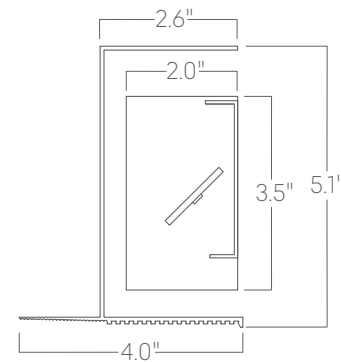

Optics

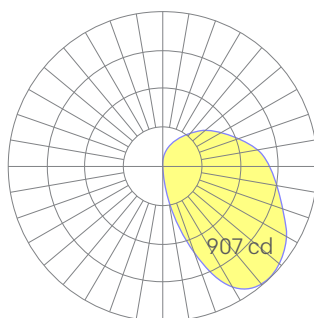

low

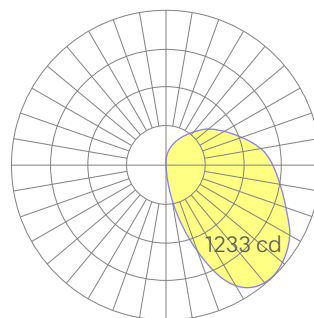

medium

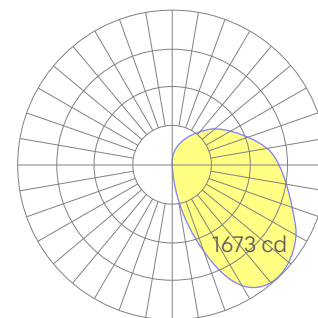

high

Representative distribution and peak candela. For other options see order information or IES files [here](#).

Easy Cove wall wash

Ordering Information

For each option group below specify one option. If you don't see your preferred option listed, contact us for [help](#).

1	Fixture ID	2	Length	3	Color Temperature	4	Output
	EZ-WW	2	2 ft	27	2700K/90 CRI	LOW	Low output
		4	4 ft	30	3000K/90 CRI	MED	Medium output
		8	8 ft	35	3500K/90 CRI	HIGH	High output
		X'-X"	Specify Length	40	4000K/90 CRI	CUST	Custom output Specify watts or lumens
		PAT	Pattern (Consult Factory)	50	5000K/90 CRI		
				WD	Warm Dim 2200K-3000K Must use WD10 driver.		
				TW	Tunable White 2700K-6500K Must use TW10 driver.		
5	Voltage	6	Driver	7	Finish	8	Mounting
	UNV Universal (120/277V)	DB	Standard 0-10V 1%	W	White	COVE-E	Lay-in to custom or pre-fabricated coves External extrusion included. See page 4 for more details.
	347V 347V Available for DB driver only	DB.1%	0-10V 0.1%	BLK	Black	COVE-NE	Lay-in to custom or pre-fabricated coves No external extrusion included. See page 4 for more details.
		ELV	Reverse Phase 1% (120V only) For compatible dimmers see here .	SLV	Silver		
		TRI	Forward Phase (120V only) For compatible dimmers see here .	CC	Custom Color See finish options here .		
		LDE	Lutron Digital EcoSystem				
		DALI	DALI-2 driver				
		PoE	Power over ethernet.				
		TW10	Dual channel, 0-10V for tunable white.				
		WD10	0-10V warm dim				
		DMX	DMX512 All DMX drivers set to default address 001 and provided in remote enclosures. Contact us for other addressing needs				
9	Optics	10	Sensors/Controls	11	Circuit	12	Options
	WAO Wide asymmetric optic	NA	None	NA	None	NA	None
		ACM	Acuity nLight Module Only	EMPCK	Emergency battery pack		
		CCS	Casambi Module	EMCKT	Emergency circuit May require additional power feeds.		
		AWNDR	Lutron Athena Wireless Node Module	DAYCKT	Daylight circuit May require additional power feeds.		
		OTHER	Consult Factory				

Performance

Output ¹	Watts/ft	Lumens/ft
Low	5	540
Medium	7	735
High	10	997

¹Based on a typically configured 90 CRI, 3500K luminaire using one driver. Custom outputs available. Please consult factory.
For 4000K multiply by 1.02, for 3000K 0.98, for 2700K 0.96, these multipliers also apply to Tunable White.
For Tunable White outputs, multiply by 1.05 for 5000K and by 1.1 for 6500K.

Technical Information



click [here](#) or scan QR code

Wiring diagrams, PoE and sensor details

Easy Cove wall wash

Drivers & Electrical

Integral drivers* with 0-10V Dimming standard. Several other driver options available; see ordering information.

*DMX drivers are provided in remote enclosures.

Controls

Control modules may be mounted within luminaires or remotely.

Emergency Back-Up

For fixtures three-feet or longer, a 4W integral emergency driver may be wired to 4ft sections. 7W, 10W, and 12W drivers are also available (not all integral; consult factory). Emergency circuits for use with building generators are also available.

PoE (Power over Ethernet)

Compatible with virtually all PoE systems including Molex Coresync, Igor, Smartengine, Platformatics, and NuLED SPICEbox.

Consult factory for systems not listed. See [here](#) for more info.

Finishes

All luminaires are finished in high quality polyester powder coating. Our standard color is white. Any RAL color may be specified.

Weight

5 lbs per foot

Patterns

Featuring illuminated welded corners and angles. Consult factory for custom designs and elevations.

Optics

Extruded satin, acrylic lenses provide excellent diffusion and high transmission.

Construction

Housings are extruded premium, recycled aluminum. Individual fixtures are available up to 12' long and may be specified as nominal or precision lengths. Precision lengths are supplied within 1/8" tolerance.

Joined Runs

Using factory-supplied quick connectors, runs up to fifty feet long may be daisy-chained to a single, line-voltage-fed starter fixture.

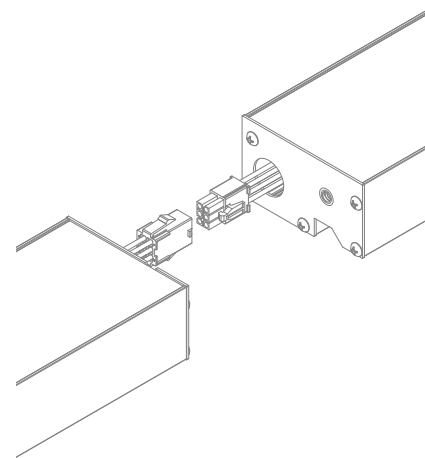

Representative joinery. For product specific details see installation guides or submittal drawings.

Square



V



Custom

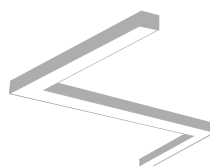

Easy Cove wall wash

Mounting Options

Custom mounting types and ceiling transitions available; consult factory.

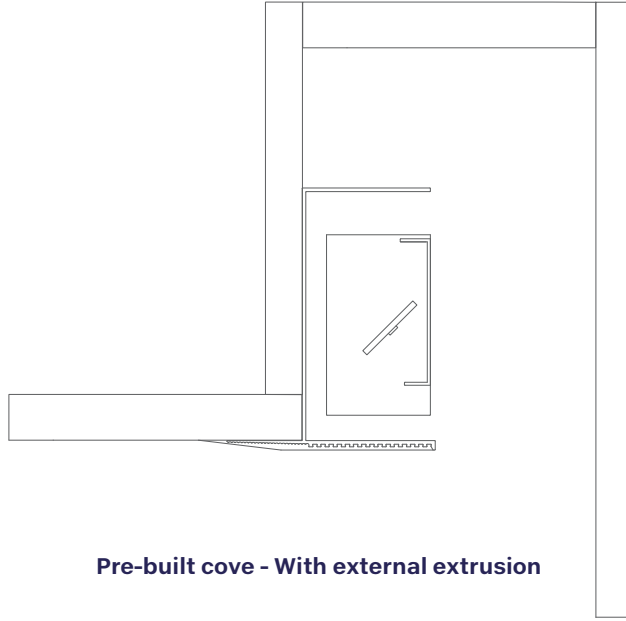

Pre-built cove - With external extrusion

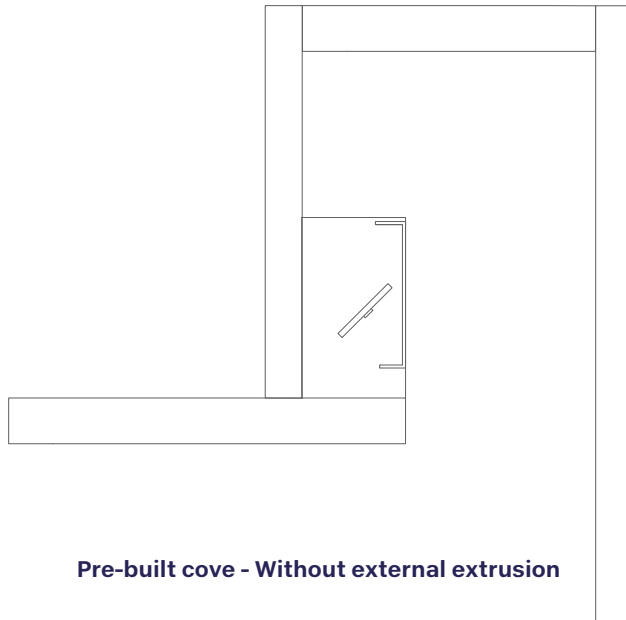

Pre-built cove - Without external extrusion

For all example mounting options shown above, ceiling by others.