

# LS1 Low Profile direct

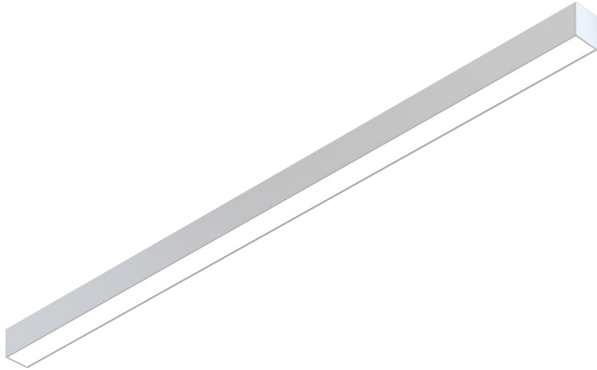

The LS Series of architectural luminaires offers a wide range of profiles and mounting options. Custom lengths and patterns are tailored to suit any modern space.

## Features

- Extruded, recycled aluminum housing
- Aluminum core LED boards, specifiable optics
- Specifiable color temperature. CRI > 90, R9 >50
- Custom lengths, welded patterns, and finishes available
- Specifiable dimmable drivers or PoE
- 5 Year, 50,000 hour warranty, damp location rated
- WELL Building Standard compatible [learn more](#)

## Dimensions

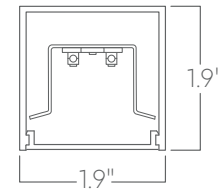

## Optics

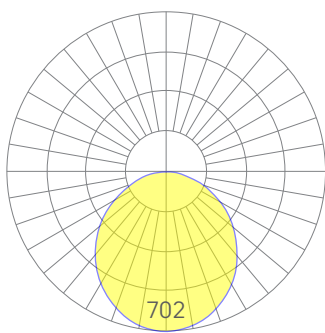

low

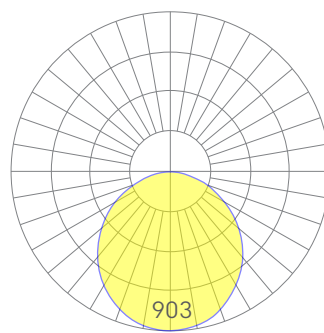

medium

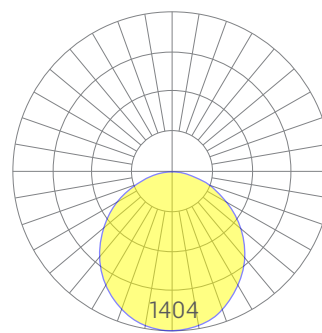

high

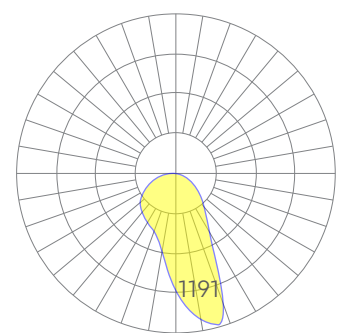

avi-asymmetric

Representative distribution and peak candela. For other options see order information or IES files [here](#).

# LS1 Low Profile direct

## Ordering Information



Example: LS1 LP - 8 - 35 - MED - UNV - DB - W - AC - FL - CCS - DAYCKT - NA

<b>Fixture ID</b> <input type="text" value="1"/>	<b>Length</b> <input type="text" value="2"/>	<b>Color Temperature</b> <input type="text" value="3"/>	<b>Output</b> <input type="text" value="4"/>
LS1 LP	<b>2</b> 2 ft <b>4</b> 4 ft <b>8</b> 8 ft <b>X'-X"</b> Specify Length <b>PAT</b> Pattern (Consult Factory)  <small>*Precision lengths may be specified to the nearest 1/8".</small>	<b>27</b> 2700K/90 CRI <b>30</b> 3000K/90 CRI <b>35</b> 3500K/90 CRI <b>40</b> 4000K/90 CRI <b>50</b> 5000K/90 CRI  <b>WD</b> <sup>1</sup> Warm Dim 2200K-3000K <b>TW</b> <sup>2</sup> Tunable White 2700K-6500K  <small><sup>1</sup>Must use WD10 driver. <sup>2</sup>Must use TW10 or PSQdriver.</small>	<b>LOW</b> Low output <b>MED</b> Medium output <b>HIGH</b> High output <b>CUST</b> Custom output!  <small>*consult factory</small>
<b>Voltage</b> <input type="text" value="5"/>	<b>Driver</b> <input type="text" value="6"/>	<b>Finish</b> <input type="text" value="7"/>	<b>Mounting</b> <input type="text" value="8"/>
<b>UNV</b> Universal (120/277V) <b>347V</b> 347V	<b>DB</b> Standard 0-10V 1% <b>DB.1%</b> 0-10V 0.1% <b>ELV</b> <sup>2</sup> Reverse Phase 1% (120V only) <b>TRI</b> <sup>2</sup> Forward phase (120V only) <b>LDE1</b> Lutron Digital EcoSystem <b>DALI</b> DALI-2 Driver <b>PoE</b> Power over Ethernet. <b>DMX</b> <sup>1</sup> DMX512  <small><sup>1</sup>Set to default address 001. Contact us for other addressing needs. <sup>2</sup>For compatible dimmers, click here.</small> <small>*Must use DB Driver</small> <small>All drivers remote</small>	<b>W</b> White <b>BLK</b> Black <b>SLV</b> Silver <b>CC</b> <sup>1</sup> Custom Color <b>CWF</b> <sup>1</sup> Custom Wood Finish  <small>*Custom Color. See finish options here. White SJ cord and canopy provided; for other requests, see section 12 to specify.</small>	<b>AC</b> Aircraft Cable (50") <b>AC3.5</b> 3.5" canopy + jbox adaptor <sup>1</sup> <b>ACPC</b> Aircraft cable to Conduit Pipe Canopy Surface Mount <b>SM</b> Wall Mount <b>WM</b> Pendant Stem <b>PS-X</b> (12", 18", 24", 36", 48")  <small><sup>1</sup>Adaptor must be mudded-in White stems and canopy provided unless otherwise specified in options (section 12).</small>
<b>Optics</b> <input type="text" value="9"/>	<b>Sensors/Controls</b> <input type="text" value="10"/>	<b>Circuit</b> <input type="text" value="11"/>	<b>Options</b> <input type="text" value="12"/>
<b>FL</b> Flat diffuser <b>AVI ASY</b> Asymmetric optic	<b>NA</b> None <b>ACM</b> Acuity nLight Module Only <b>CCS</b> Casambi Module <b>AWNRR</b> Lutron Athena Wireless Node Module  <small>Consult factory for other options.</small>	<b>NA</b> None <b>EMPCK</b> Emergency Battery Pack <b>EMCKT</b> Emergency Circuit <b>DAYCKT</b> Daylight Circuit	<b>STD</b> White Canopy + White Cord <b>CAN-X</b> <sup>1</sup> Canopy + color <b>SJ-X</b> <sup>2</sup> SJ Cord + color  <small><sup>1</sup>See finish options here. <sup>2</sup>SJ Cord only available in White or Black.</small>

## Performance

Output <sup>1</sup>	Watts/ft	Lumens/ft	LPW
Low	5	474	95
Medium	7	677	97*
High	10	948	95

<sup>1</sup>Based on a typically configured 90 CRI, 3500K luminaire using one driver. Custom outputs available. Please consult factory.  
For 4000K multiply by 1.05, for 3000K 0.96, for 2700K, 0.92

\*80 CRI equivalent 115 LPW

## Technical Information



click [here](#) or scan QR code

Wiring diagrams, PoE and sensor details

Modification date: February 2023

Page 2 of 4

# LS1 Low Profile direct

## Drivers & Electrical

Remote, dimmable drivers are supplied in enclosures. For remote driver box sizes, click [here](#).

## Emergency Back-Up

For fixtures three-feet or longer, a 4W integral emergency driver may be wired to 4ft sections. 7W, 10W, and 12W drivers are also available (not all integral; consult factory). Emergency circuits for use with building generators are also available.

## PoE (Power over Ethernet)

Compatible with virtually all PoE systems including Molex Coresync, Igor, Smartengine, Platformatics, and NuLED SPICEbox. Consult Factory for systems not listed, See [here](#) for more info.

## Finishes

All luminaires are finished in high quality polyester powder coating. Our standard color is white. Any RAL color may be specified.

## Weight

3 lbs per foot.

## Optics

Extruded satin acrylic lenses provide excellent diffusion, high transmission, and no LED imaging. Black Optic and glare-free, beam-controlling TIR optics are available for some models.

## Construction

Extruded, recycled aluminum housing.

## Joined Runs

Runs of any length may be specified and are comprised of multiple, factory-engineered, joined sections. Individually specified luminaires are not field joinable.

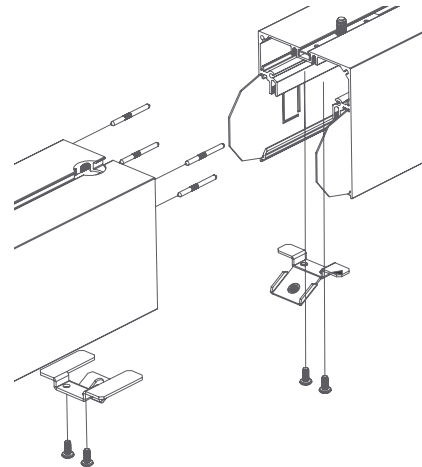

Representative joinery. For product specific details see installation guides or submittal drawings.

## Patterns

Featuring illuminated welded corners and angles. Consult factory for custom designs and elevations.

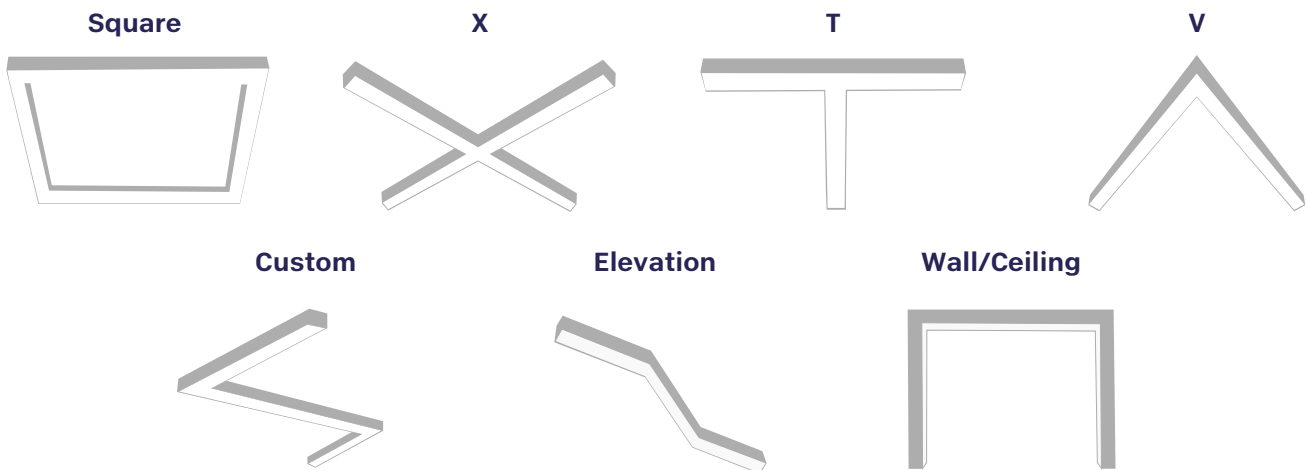

# LS1 Low Profile direct

## Mounting Options

Custom mounting types and ceiling transitions available; consult factory.

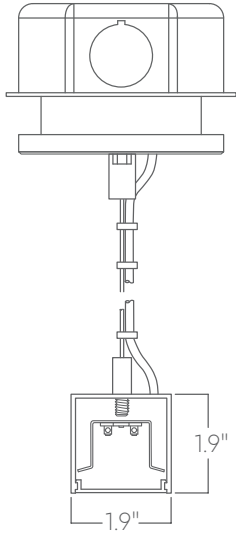

**Aircraft cable  
3.5" canopy**

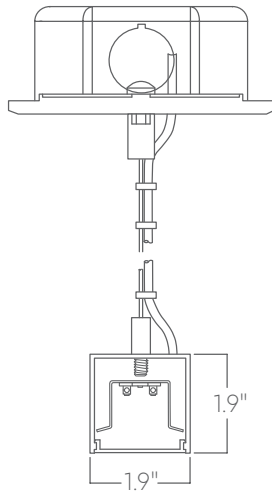

**Aircraft cable  
5" canopy**

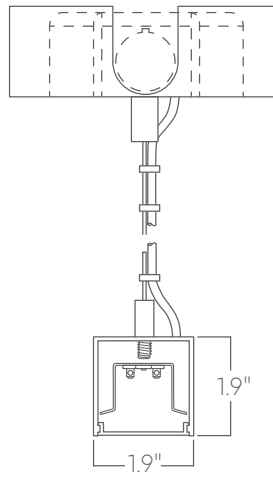

**Aircraft cable  
Conduit canopy  
with knockouts**

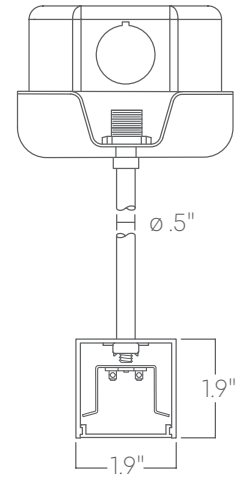

**Pendant stem**

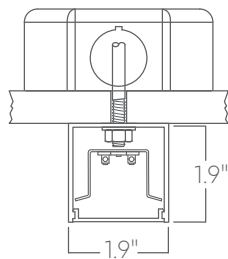

**Surface mount**

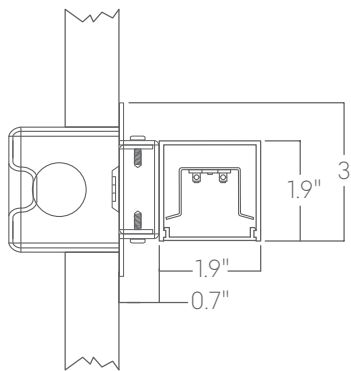

**Wall mount**