

Joint

Linear modular system

A slim linear system using specifiable modular connection types. Custom lengths and endless configurations.

Joint Connector



Modular connection points for linear patterns.

Features

- Several connection types for various configurations
- 30 degree elevations
- Extruded, recycled, premium aluminum
- 5 Year, 50,000 hour warranty
- Damp location rated

Ordering Information

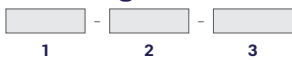

Example: JOINT-CNCT - 90° - BLK

Fixture ID	1	Connection Type	2	Finish	3
JOINT-CNCT		90° 90° Corner 120° 120° Corner Y 120° 'Y' Pattern X 'X' Pattern T 'T' Pattern		W White BLK Black SLV Silver CC' Custom Color	

*Drawing required upon ordering

*Custom Color. See finish options [here](#).

Dimensions

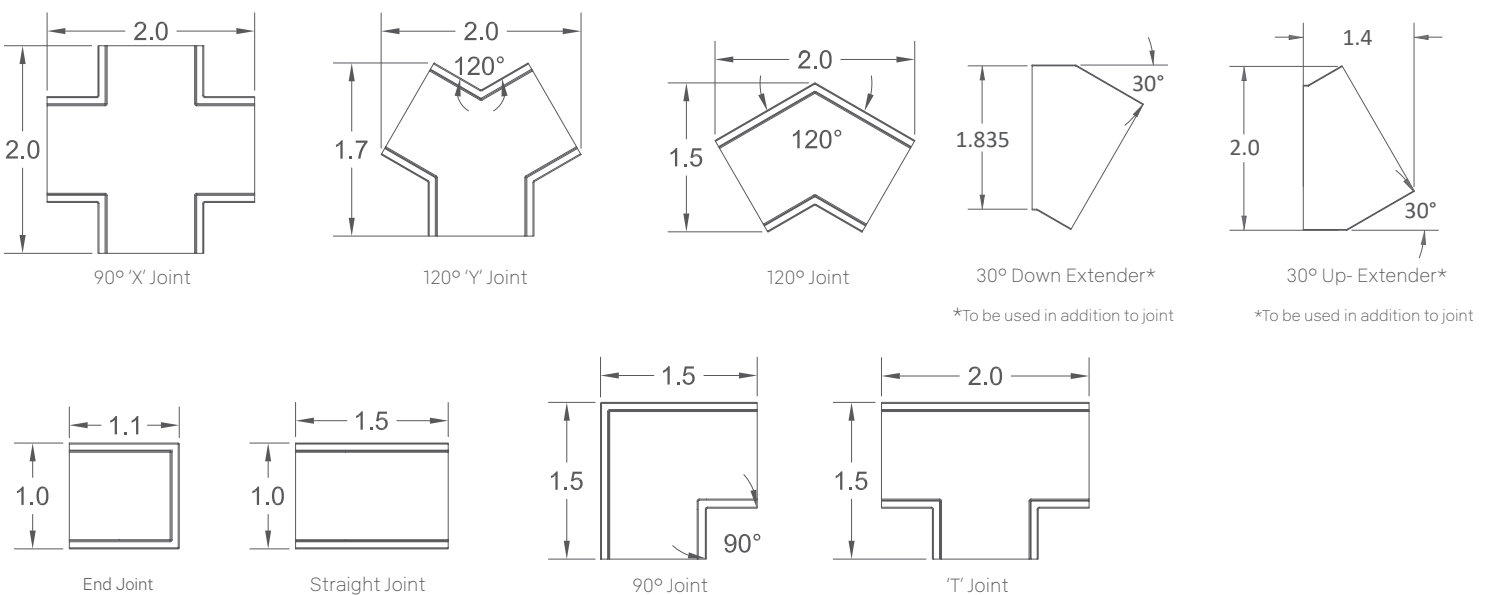

Modification date: June,2023

Page 2 of 7

Joint - Linear direct

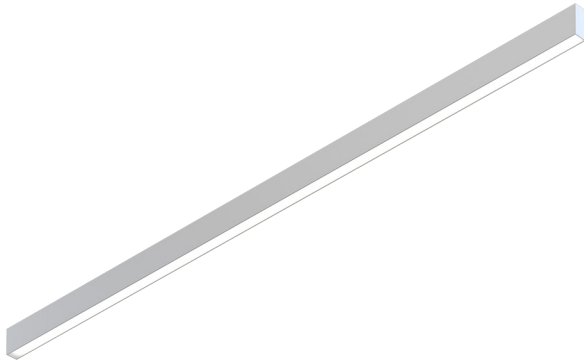

Linear component available in custom lengths and patterns.

Features

- Extruded, recycled, premium aluminum housing
- Aluminum core LED boards, specifiable optics
- Specifiable color temperature. CRI > 90, R9 >50
- 5 Year, 50,000 hour warranty, damp location rated

Dimensions

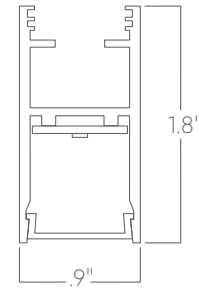

Optics

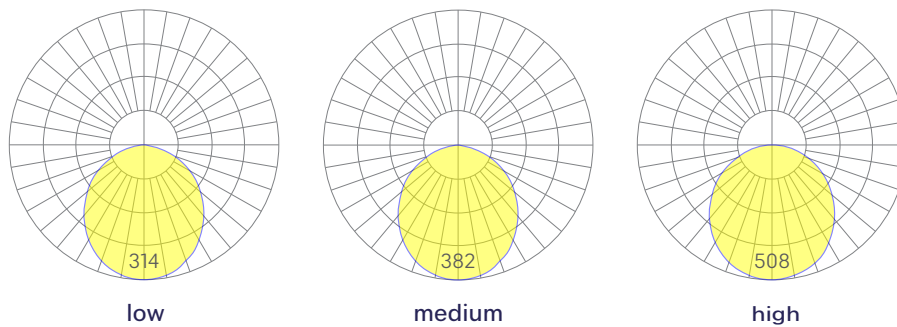

Representative distribution and peak candela. For other options see order information or IES files [here](#).

Joint - Linear direct

Ordering Information



Example: JOINT LIN - 8 - 35 - MED - UNV - DB - W - AC - SD - CCS - DAYCKT - NA

Fixture ID <input type="text" value="1"/>	Length <input type="text" value="2"/>	Color Temperature <input type="text" value="3"/>	Output <input type="text" value="4"/>
JOINT LIN	4 4 ft 8 8 ft X'-X" Specify Length ¹ *Drawing must be submitted designating connector type(s) and placement. Straight connector required for lengths over 8ft ¹ Precision lengths may be specified to the nearest 1/8". All lengths are nominal unless specified to be exact.	27 2700K/90 CRI 30 3000K/90 CRI 35 3500K/90 CRI 40 4000K/90 CRI	LOW Low output MED Medium output HIGH High output CUST Custom output ¹ ¹ consult factory
Voltage <input type="text" value="5"/>	Driver <input type="text" value="6"/>	Finish <input type="text" value="7"/>	Mounting <input type="text" value="8"/>
UNV 347V¹ Universal (120/277V) 347V	DB Standard 0-10V 1% DB.1% 0-10V 0.1% ELV² Reverse Phase 1% (120V only) TRI² Forward phase (120V only) LDE1 Lutron Digital EcoSystem DALI DALI-2 Driver PoE Power over Ethernet. DMX¹ DMX512 ¹ Set to default address 001. Contact us for other addressing needs. ² For compatible dimmers, click here . All drivers remote	W White BLK Black SLV Silver CC¹ Custom Color	AC Aircraft Cable (50") AC3.5 3.5" canopy + jbox adaptor ¹ ¹ Adaptor must be mudded-in White stems and canopy provided unless otherwise specified in options (section 11).
Optics <input type="text" value="9"/>	Sensors/Controls <input type="text" value="10"/>	Circuit <input type="text" value="11"/>	Options <input type="text" value="12"/>
SD Standard Diffuser	NA None ACM Acuity nLight Module Only CCS Casambi Module AWNRR Lutron Athena Wireless Node Module Consult factory for other options.	NA None EMPCK Emergency Battery Pack EMCKT Emergency Circuit DAYCKT Daylight Circuit	STD White Canopy + White Cord CAN-X¹ Canopy + color SJ-X² SJ Cord + color ¹ See finish options here . ² SJ Cord only available in White or Black.

Performance

Output ¹	Watts/ft	Lumens/ft
Low	4	210
Medium	5	315
High	7	400

¹Based on a typically configured 90 CRI, 3500K luminaire using one driver.

Custom outputs available. Please consult factory.
 For 4000K multiply by 105; for 3000K 0.9%; for 2700K, 0.92.

Technical Information



click [here](#) or scan QR code

Wiring diagrams, PoE and sensor details

Joint - Linear indirect/direct

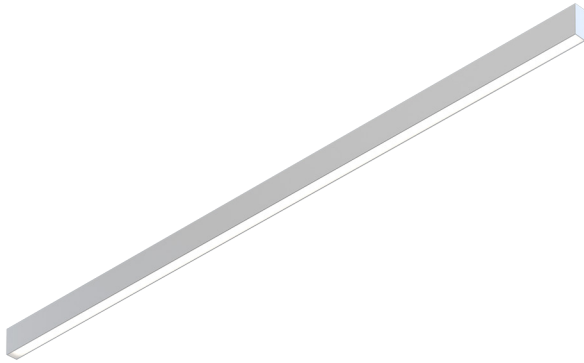

Linear component available in custom lengths and patterns.

Features

- Extruded, recycled, premium aluminum housing
- Aluminum core LED boards, specifiable optics
- Specifiable color temperature. CRI > 90, R9 >50
- 5 Year, 50,000 hour warranty, damp location rated

Dimensions

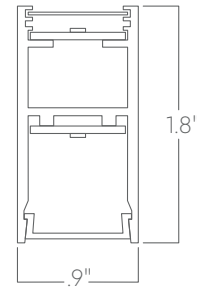

Optics

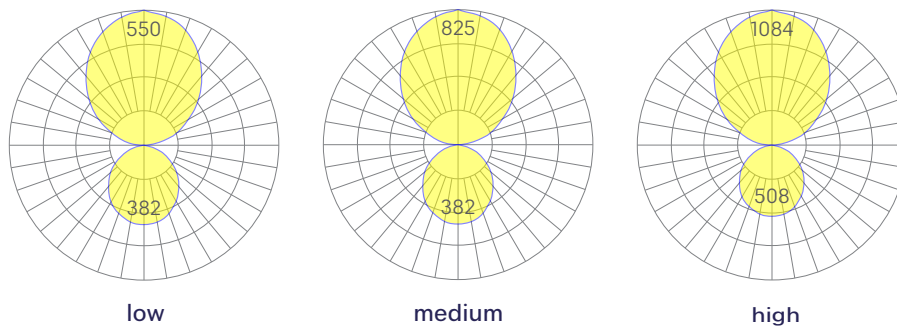

Representative distribution and peak candela. For other options see order information or IES files [here](#).

Joint - Linear indirect/direct

Ordering Information



Example: JOINT LIN UPDN - 8 - 35 - MED - MED - UNV - DB - W - AC - SD - SD - CCS - DAYCKT - NA

Fixture ID <input type="text" value="1"/>	Length <input type="text" value="2"/>	Color Temperature <input type="text" value="3"/>	Output <input type="text" value="4a-"/> <input type="text" value="4b-"/>
JOINT LIN UPDN	4 4 ft 8 8 ft X"-X" Specify Length ¹ *Drawing must be submitted designating connector type(s) and placement. Straight connector required for lengths over 8ft ¹ Precision lengths may be specified to the nearest 1/8". All lengths are nominal unless specified to be exact.	27 2700K/90 CRI 30 3000K/90 CRI 35 3500K/90 CRI 40 4000K/90 CRI	4a - Indirect LOW Low output MED Medium output HIGH High output CUST Custom output! 4b - Direct LOW Low output MED Medium output HIGH High output CUST Custom output! ¹ consult factory
Voltage <input type="text" value="5"/>	Driver <input type="text" value="6"/>	Finish <input type="text" value="7"/>	Mounting <input type="text" value="8"/>
UNV 347V¹ Universal (120/277V) 347V	DB Standard 0-10V 1% DB.1% 0-10V 0.1% ELV² Reverse Phase 1% (120V only) TRI² Forward phase (120V only) LDE1 Lutron Digital EcoSystem DALI DALI-2 Driver PoE Power over Ethernet. DMX¹ DMX512 ¹ Set to default address 001. Contact us for other addressing needs. ² For compatible dimmers, click here . All drivers remote	W White BLK Black SLV Silver CC¹ Custom Color	AC Aircraft Cable (50") AC3.5 3.5" canopy + jbox adaptor ¹
Optics <input type="text" value="9a-"/> <input type="text" value="9b-"/>	Sensors/Controls <input type="text" value="10"/>	Circuit <input type="text" value="11"/>	Options <input type="text" value="12"/>
9a - Indirect SD Standard Diffuser 9b - Direct SD Standard Diffuser	NA None ACM Acuity nLight Module Only CCS Casambi Module AWNRR Lutron Athena Wireless Node Module Consult factory for other options.	NA None DC¹ Dual Circuit (separate indirect/direct control) EMPKK Emergency battery pack EMCKT¹ Emergency circuit DAYCKT¹ Daylight circuit ¹ May require additional power feeds. Consult factory	STD White Canopy + White Cord CAN-X¹ Canopy + color SJ-X² SJ Cord + color ¹ See finish options here . ² SJ Cord only available in White or Black.

Performance

Output ¹	indirect		direct	
	Watts/ft	Lumens/ft	Watts/ft	Lumens/ft
Low	4	299	4	210
Medium	5	445	5	315
High	7	583	7	400

¹Based on a typically configured 90 CRI, 3500K luminaire using one driver.

Custom outputs available. Please consult factory.
For 4000K multiply by 1.05; for 3000K 0.96; for 2700K, 0.92.

Technical Information



click [here](#) or scan QR code

Wiring diagrams, PoE and sensor details

Drivers & Electrical

Remote, dimmable drivers are supplied in enclosures.
For remote driver box sizes, click [here](#).

Sensors & Controls

Sensors are installed on an aluminum plate adjacent to the luminaire lens¹. Coronet remains agnostic in our approach to sensors and control systems; our fixtures are compatible with most systems offered.

¹Not applicable to indirect only models. Consult factory.

Emergency Back-Up

For fixtures three-feet or longer, a 4W integral emergency driver may be wired to 4ft sections. 7W, 10W, and 12W drivers are also available (not all integral; consult factory). Emergency circuits for use with building generators are also available.

PoE (Power over Ethernet)

Compatible with virtually all PoE systems including Molex Coresync, Igor, Smartengine, Platformatics, and NuLED SPICEbox.
Consult Factory for systems not listed, See [here](#) for more info.

Finishes

All luminaires are finished in high quality polyester powder coating.
Our standard color is white. Any RAL color may be specified.

Weight

2 lbs per foot

Optics

Extruded satin acrylic lenses provide excellent diffusion, high transmission, and no LED imaging.

Construction

Housings are extruded premium, recycled aluminum. Individual fixtures are available up to 12' long and may be specified as nominal or precision lengths. Precision lengths are supplied within 1/8" tolerance.