

# Duarte indirect/direct

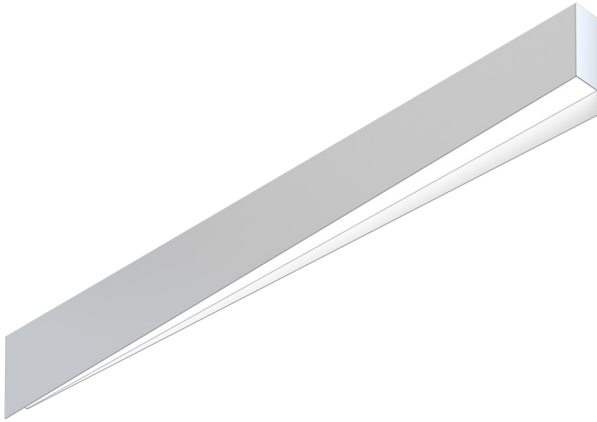

Our linear architectural luminaires offer a wide range of profiles and mounting options. Custom lengths are tailored to suit any modern space.

## Features

- Extruded, recycled aluminum housing
- Aluminum core LED boards, specifiable outputs
- Specifiable color temperature. CRI > 90, R9 >50
- Custom lengths and finishes available
- Specifiable dimmable drivers or PoE
- 5 Year, 50,000 hour warranty, damp location rated
- WELL Building Standard compatible [learn more](#)

## Dimensions

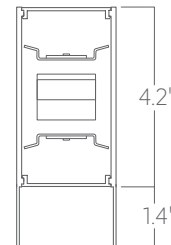

## Optics

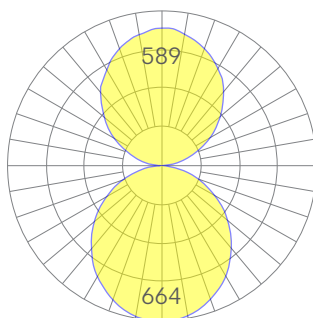

low

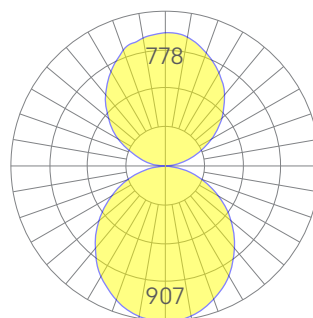

medium

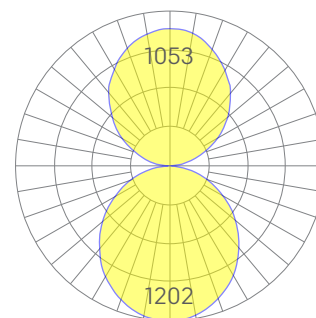

high

Representative distribution and peak candela. For other options see order information or IES files [here](#).

# Duarte indirect/direct

## Ordering Information



Example: DUARTE UPDN - 8 - 35 - MED - MED - UNV - DB - W - AC - SD - SD - CCS - DAYCKT - NA

<b>Fixture ID</b> <input type="text" value="1"/>	<b>Length</b> <input type="text" value="2"/>	<b>Color Temperature</b> <input type="text" value="3"/>	<b>Output</b> <input type="text" value="4a-"/> <input type="text" value="4b-"/>	
<b>DUARTE UPDN</b>	<b>2</b> 2 ft <b>4</b> 4 ft <b>8</b> 8 ft <b>X'-X"</b> Specify length <sup>1</sup>	<b>27</b> 2700K/90 CRI <b>30</b> 3000K/90 CRI <b>35</b> 3500K/90 CRI <b>40</b> 4000K/90 CRI <b>50</b> 5000K/90 CRI  <b>WD</b> <sup>1</sup> Warm Dim 2200K-3000K <b>TW</b> <sup>2</sup> Tunable White 2700K-6500K <b>RGBW30</b> <sup>3</sup> RGB +white, 3000k <b>RGBW35</b> <sup>3</sup> RGB +white, 3500k <b>RGBW40</b> <sup>3</sup> RGB +white, 4000k	<b>4a - Indirect</b> <b>LOW</b> Low output <b>MED</b> Medium output <b>HIGH</b> High output <b>CUST</b> Custom output <sup>1</sup>  <b>4b - Direct</b> <b>LOW</b> Low output <b>MED</b> Medium output <b>HIGH</b> High output <b>CUST</b> Custom output <sup>1</sup>	
<small><sup>1</sup>Precision lengths may be specified to the nearest 1/8". However, no length longer than 8ft. All lengths are nominal unless specified to be exact.</small>	<small><sup>1</sup>Must use WD10 driver. <sup>2</sup>Must use TW10 or PSQ driver. <sup>3</sup>Must use remote DMX driver. "High" output not available.</small>	<small><sup>1</sup>consult factory</small>		
<b>Voltage</b> <input type="text" value="5"/>	<b>Driver</b> <input type="text" value="6"/>	<b>Finish</b> <input type="text" value="7"/>	<b>Mounting</b> <input type="text" value="8"/>	
<b>UNV</b> Universal (120/277V) <b>347V</b> 347V	<b>DB</b> Standard 0-10V 1% <b>DB.1%</b> 0-10V 0.1% <b>ELV</b> <sup>2</sup> Reverse Phase 1% (120V only) <b>TRI</b> <sup>2</sup> Forward phase (120V only) <b>LDE1</b> Lutron Digital EcoSystem <b>DALI</b> DALI-2 Driver <b>PoE</b> Power over ethernet <b>TW10</b> Dual channel, 0-10V for tunable white. <b>WD10</b> 0-10V Warm Dim <b>PSQ</b> Lutron T-Series 2-channel 1% for tunable white <b>DMX</b> <sup>1</sup> DMX512	<b>W</b> White <b>BLK</b> Black <b>SLV</b> Silver <b>CC</b> <sup>1</sup> Custom Color <b>CWF</b> <sup>1</sup> Custom Wood Finish	<b>AC</b> Aircraft cable (50") <b>AC3.5</b> 3.5" canopy + jbox adaptor <sup>1</sup> <b>ACPC</b> Aircraft cable to Conduit <b>PS-X</b> Pipe Canopy Pendant stem (12", 18", 24", 36", 48")	
<small><sup>1</sup>Must use DB Driver</small>	<small><sup>1</sup>Set to default address 001. Contact us for other addressing needs. All DMX drivers provided in remote enclosures. <sup>2</sup>For compatible dimmers, click here.</small>	<small><sup>1</sup>Custom Color. See finish options here. White SJ cord and canopy provided; for other requests, see section 12 to specify.</small>	<small><sup>1</sup>Adaptor must be mudded-in White stems and canopy provided unless otherwise specified in options (section 12).</small>	
<b>Optics</b> <input type="text" value="9a-"/> <input type="text" value="9b-"/>	<b>Sensors/Controls</b> <input type="text" value="10"/>	<b>Circuit</b> <input type="text" value="11"/>	<b>Options</b> <input type="text" value="12"/>	
<b>9a - Indirect</b> <b>SD</b> Standard Diffuser <b>AVI-BAT</b> 120° Batwing  <b>9b - Direct</b> <b>SD</b> Standard Diffuser	<b>NA</b> None <b>ACM</b> Acuity nLight Module Only <b>CCS</b> Casambi Module <b>AWNRR</b> Lutron Athena Wireless Node Module	<b>NA</b> None <b>DC</b> <sup>1</sup> Dual Circuit (separate indirect/direct control) <b>EMPCK</b> Emergency battery pack <b>EMCKT</b> <sup>1</sup> Emergency circuit <b>DAYCKT</b> <sup>1</sup> Daylight circuit	<b>STD</b> White Canopy + White Cord <b>CAN-X</b> <sup>1</sup> Canopy + color <b>SJ-X</b> <sup>2</sup> SJ Cord + color	
<small>Consult factory for other options.</small>		<small><sup>1</sup>May require additional power feeds. Consult factory</small>	<small><sup>1</sup>See finish options here. <sup>2</sup>SJ Cord only available in White or Black.</small>	

## Performance

Output <sup>1</sup>	indirect		direct	
	Watts/ft	Lumens/ft	Watts/ft	Lumens/ft
Low	5	382	5	404
Medium	7	519	7	549
High	10	686	10	720

<sup>1</sup>Based on a typically configured 90 CRI, 3500K luminaire using one driver.

Custom outputs available. Please consult factory.  
For 4000K multiply by 1.05; for 3000K 0.9; for 2700K, 0.92

## Technical Information



click [here](#) or scan QR code

Wiring diagrams, PoE and sensor details

Modification date: June,2023

Page 2 of 4

# Duarte indirect/direct

## Drivers & Electrical

Integral drivers\* with 0-10V Dimming standard. Several other driver options available; see ordering information.

\*DMX drivers are provided in remote enclosures.

## Sensors & Controls

Sensors are installed on an aluminum plate adjacent to the luminaire lens<sup>1</sup>. Coronet remains agnostic in our approach to sensors and control systems; our fixtures are compatible with most systems offered.

<sup>1</sup>Not applicable to indirect only models. Consult factory.

## Emergency Back-Up

For fixtures three-feet or longer, a 4W integral emergency driver may be wired to 4ft sections. 7W, 10W, and 12W drivers are also available (not all integral; consult factory). Emergency circuits for use with building generators are also available.

## PoE (Power over Ethernet)

Compatible with virtually all PoE systems including Moxel Coresync, Igor, Smartengine, Platformatics, and NuLED SPICEbox. Consult Factory for systems not listed, See [here](#) for more info.

## Finishes

All luminaires are finished in high quality polyester powder coating. Our standard color is white. Any RAL color may be specified.

## Weight

6lbs per foot

## Optics

Extruded satin acrylic lenses provide excellent diffusion, high transmission, and no LED imaging.

## Construction

Housings are extruded premium, recycled aluminum. Individual fixtures are available up to 8' long and may be specified as nominal or precision lengths. Precision lengths are supplied within 1/8" tolerance.

# Duarte indirect/direct

## Mounting Options

Custom mounting types and ceiling transitions available; consult factory.

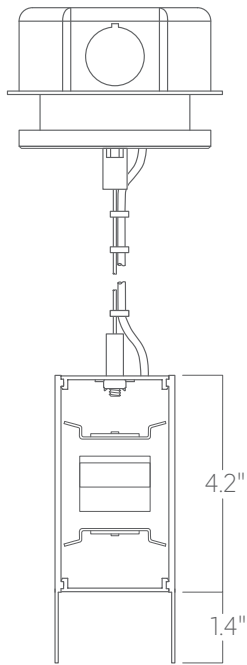

**Aircraft cable  
3.5" canopy**

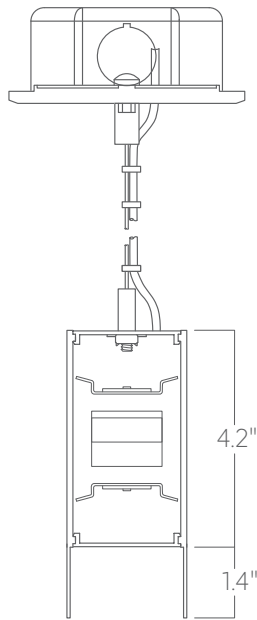

**Aircraft cable  
5" canopy**

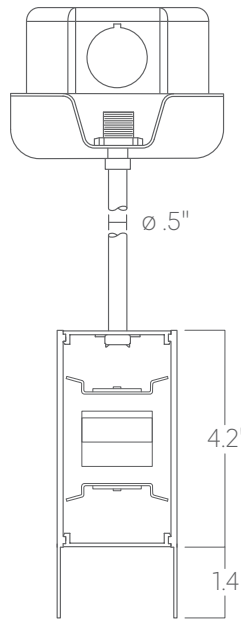

**Pendant stem**

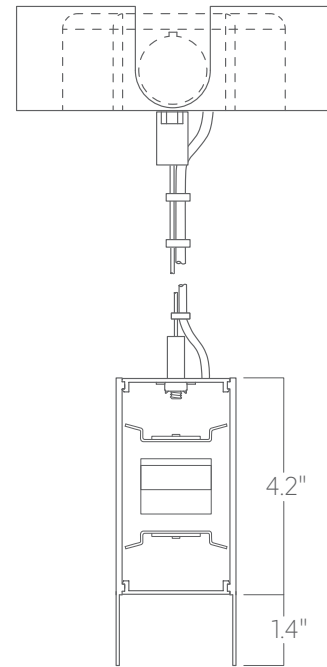

**Aircraft cable  
Conduit canopy  
with knockouts**