

# LS1 Sharp indirect/direct

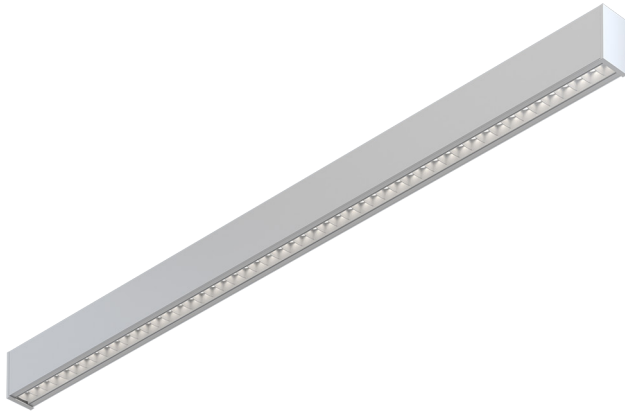

The Sharp Series of architectural luminaires features slim profiles, glare free, beam shaping optical cells and several mounting options. Custom lengths are tailored to suit any modern space.

## Features

- Extruded, recycled aluminum housing
- Glare free, beam shaping optical cells
- Aluminum core LED boards, specifiable optics
- Specifiable color temperature. CRI > 90, R9 >50
- Custom finishes available
- Specifiable dimmable drivers or PoE
- 5 Year, 50,000 hour warranty, damp location rated
- WELL Building Standard compatible [learn more](#)

## Dimensions

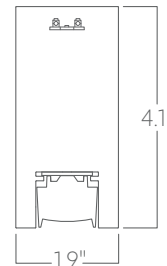

## Optics

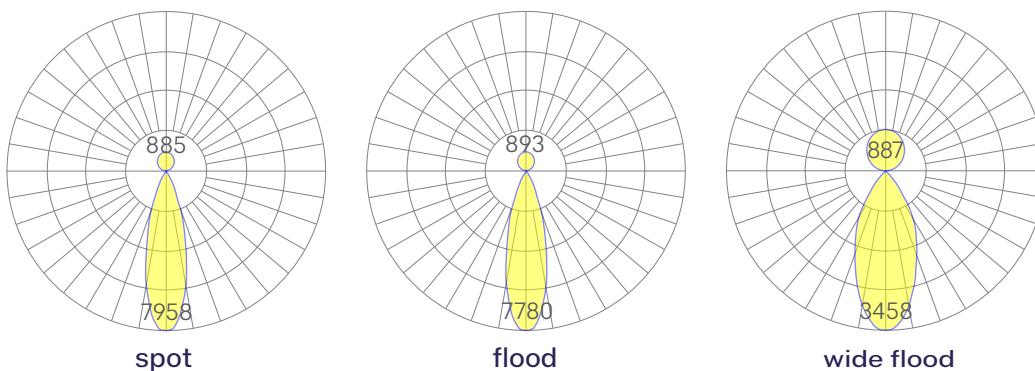

Representative distribution and peak candela. For other options see order information or IES files [here](#).

# LS1 Sharp indirect/direct

## Ordering Information



Example: LS1 SHARP UPDN - 8 - 35 - MED - MED - UNV - DB - W - W - AC - FL - WFL - CCS - DAYCKT - NA

<b>Fixture ID</b> <input type="text" value="1"/>	<b>Length</b> <input type="text" value="2"/>	<b>Color Temperature</b> <input type="text" value="3"/>	<b>Output</b> <input type="text" value="4a-"/> <input type="text" value="4b-"/>	
<b>LS1 SHARP UPDN</b>	<b>2</b> 2 ft <b>4</b> 4 ft <b>8</b> 8 ft <b>X'X"</b> <sup>1</sup> Specify Length  <small><sup>1</sup>Custom lengths available in 12" nominal increments. All lengths are nominal unless specified to be exact.</small>	<b>27</b> 2700K/90 CRI <b>30</b> 3000K/90 CRI <b>35</b> 3500K/90 CRI <b>40</b> 4000K/90 CRI	<b>4a - Indirect</b> <b>LOW</b> Low output <b>MED</b> Medium output <b>HIGH</b> High output <b>CUST</b> Custom output <sup>1</sup>  <b>4b - Direct</b> <b>LOW</b> Low output <b>MED</b> Medium output <b>HIGH</b> High output <b>CUST</b> Custom output <sup>1</sup>  <small><sup>1</sup>consult factory</small>	
<b>Voltage</b> <input type="text" value="5"/>	<b>Driver</b> <input type="text" value="6"/>	<b>Finish</b> <input type="text" value="7a-"/> <input type="text" value="7b-"/>	<b>Mounting</b> <input type="text" value="8"/>	
<b>UNV</b> Universal (120/277V) <b>347V<sup>1</sup></b> 347V	<b>DB</b> Standard 0-10V 1% <b>DB.1%</b> 0-10V 0.1% <b>ELV<sup>2</sup></b> Reverse Phase 1% (120V only) <b>TRI<sup>2</sup></b> Forward phase (120V only) <b>LDE1</b> Lutron Digital EcoSystem <b>DALI</b> DALI-2 Driver <b>PoE</b> Power over Ethernet. <b>DMX<sup>1</sup></b> DMX512  <small><sup>1</sup>Set to default address 001. Contact us for other addressing needs. <sup>2</sup>For compatible dimmers, click <a href="#">here</a>.</small>	<b>7a - Housing</b> <b>W</b> White <b>BLK</b> Black <b>CC<sup>1</sup></b> Custom Color  <b>7b - Louver</b> <b>W</b> White <b>BLK</b> Black  <small><sup>1</sup>Custom Color. See finish options <a href="#">here</a>. White SJ cord and canopy provided; for other requests, see section 12 to specify.</small>	<b>AC</b> Aircraft Cable (50") <b>AC3.5</b> 3.5" canopy + jbox adaptor <sup>1</sup> <b>ACPC<sup>2</sup></b> Aircraft cable to Conduit Pipe Canopy <b>PS-X</b> Pendant Stem (12", 18", 24", 36", 48")  <small><sup>1</sup>Adaptor must be mudded-in. White stems and canopy provided unless otherwise specified in options (section 12). <sup>2</sup>Not available with Power Over Aircraft Cable.</small>	
<b>Optics</b> <input type="text" value="9a-"/> <input type="text" value="9b-"/>	<b>Sensors/Controls</b> <input type="text" value="10"/>	<b>Circuit</b> <input type="text" value="11"/>	<b>Options</b> <input type="text" value="12"/>	
<b>9a - Indirect</b> <b>FL</b> Flat Diffuser <b>AVI BAT</b> 120° Batwing <b>AVI ASY</b> Asymmetric Optic  <b>9b - Direct</b> <b>SP</b> 24° Beam <b>FL</b> 30° Beam <b>WFL</b> 44° Beam	<b>NA</b> None <b>ACM</b> Acuity nLight Module Only <b>CCS</b> Casambi Module <b>AWNRR</b> Lutron Athena Wireless Node Module  <small>All control systems are remote. Consult factory for other options.</small>	<b>NA</b> None <b>DC<sup>1</sup></b> Dual Circuit (separate indirect/direct control) <b>EMPCK</b> Emergency battery pack <b>EMCKT<sup>1</sup></b> Emergency circuit <b>DAYCKT<sup>1</sup></b> Daylight circuit  <small><sup>1</sup>May require additional power feeds. Consult factory</small>	<b>STD</b> White Canopy + White Cord <b>CAN-X<sup>1</sup></b> Canopy + color <b>SJ-X<sup>2</sup></b> SJ Cord + color  <small><sup>1</sup>See finish options <a href="#">here</a>. <sup>2</sup>SJ Cord only available in White or Black.</small>	

## Performance

Output <sup>1</sup>	indirect		direct	
	Watts/ft	Lumens/ft	Watts/ft	Lumens/ft
Low	5	488	5	419
Medium	8	640	8	608
High	10	884	10	800

<sup>1</sup>Based on a typically configured 90 CRI, 3500K luminaire using one driver.

Custom outputs available. Please consult factory.  
For 4000K multiply by 1.05; for 3000K 0.9%; for 2700K, 0.92

## Technical Information



click [here](#) or scan QR code

Wiring diagrams, PoE and sensor details

Modification date: June,2023

Page 2 of 4

# LS1 Sharp indirect/direct

## Drivers & Electrical

Integral, dimmable drivers are supplied in enclosures.

## Emergency Back-Up

For fixtures three-feet or longer, a 4W integral emergency driver may be wired to 4ft sections. 7W, 10W, and 12W drivers are also available (not all integral; consult factory). Emergency circuits for use with building generators are also available.

## PoE (Power over Ethernet)

Compatible with virtually all PoE systems including Molex Coresync, Igor, Smartengine, Platformatics, and NuLED SPICEbox. Consult Factory for systems not listed, See [here](#) for more info.

## Finishes

All luminaires are finished in high quality polyester powder coating. Our standard color is white. Any RAL color may be specified.

## Weight

3 lbs per foot

## Optics

Glare free, beam shaping optical cells.

## Construction

Extruded, recycled aluminum housing with formed steel ends.

## Joined runs

Runs of any length\* may be specified and are comprised of multiple, factory-engineered, joined sections. Individually specified luminaires are not field joinable.

\*Custom lengths available in 12" nominal increments

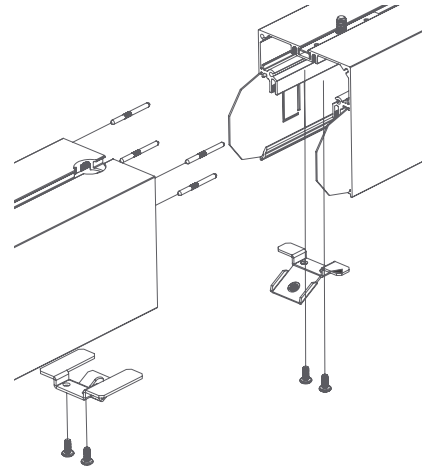

Representative joinery. For product specific details see installation guides or submittal drawings.

# LS1 Sharp indirect/direct

## Mounting Options

Custom mounting types and ceiling transitions available; consult factory.

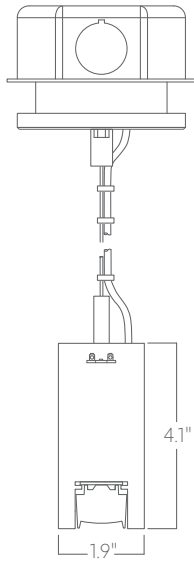

**Aircraft cable  
3.5" canopy**

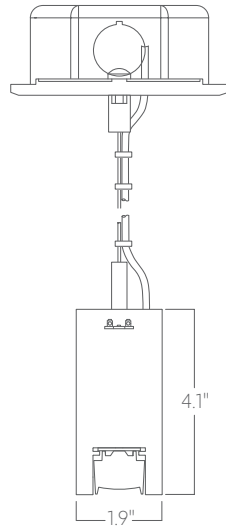

**Aircraft cable  
5" canopy**

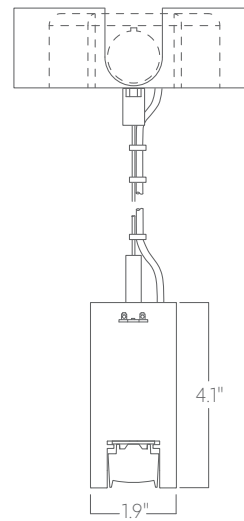

**Aircraft cable  
Conduit canopy  
with knockouts**

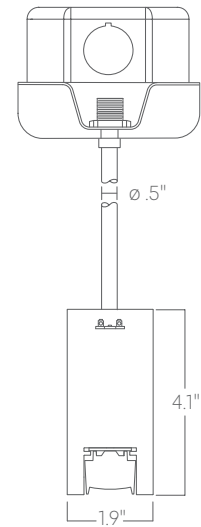

**Pendant stem**