

LSR3 Pop Out Lens recessed



The LS Series of architectural luminaires offers a wide range of profiles and mounting options. Custom lengths and patterns are tailored to suit any modern space.

Features

- Extruded recycled aluminum housing
- Aluminum core LED boards, specifiable optics
- Specifiable color temperature. CRI > 90, R9 >50
- Custom lengths, welded patterns, and finishes available
- Integral specifiable dimmable drivers or PoE
- 5 Year, 50,000 hour warranty, damp location rated
- WELL Building Standard compatible [learn more](#)

Dimensions

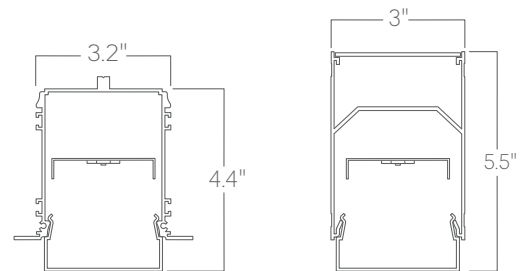

flange/mud-in flange grid/slot grid/millwork

Optics

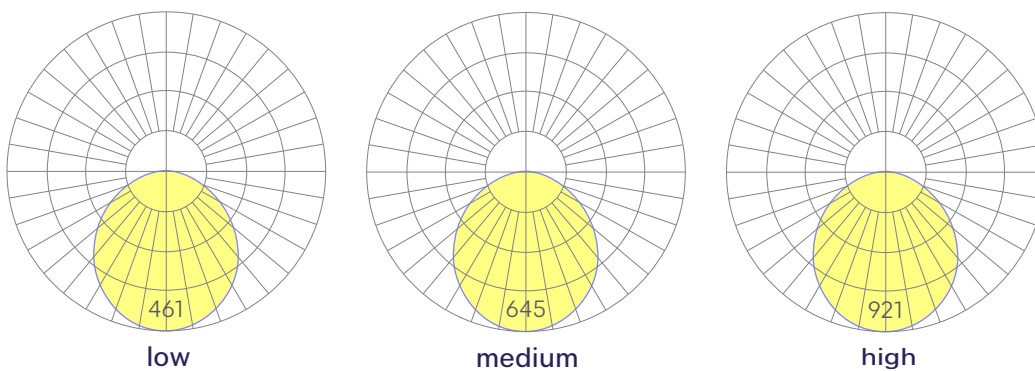

Representative distribution and peak candela. For other options see order information or IES files [here](#).

LSR3 Pop Out Lens recessed

Ordering Information



Example: LSR3 POL - 8 - 35 - MED - UNV - DB - W - NT - POL - CCS - DAYCKT - NA

Fixture ID	1	Length	2	Color Temperature	3	Output	4
LSR3 POL		2 2 ft 4 4 ft 8 8 ft X'-X" Specify Length PAT Pattern (Consult Factory)		27 2700K/90 CRI 30 3000K/90 CRI 35 3500K/90 CRI 40 4000K/90 CRI 50 5000K/90 CRI WD ¹ Warm Dim 2200K–3000K TW ² Tunable White 2700K–6500K RGBW30 ³ RGB +white, 3000k RGBW35 ³ RGB +white, 3500k RGBW40 ³ RGB +white, 4000k		LOW Low output MED Medium output HIGH High output CUST Custom output ¹	
		*Precision lengths may be specified to the nearest 1/8".		¹ Must use WD10 driver. ² Must use TW10 or PSQ driver. ³ Must use remote DMX driver. "High" output not available.		*consult factory	
Voltage	5	Driver	6	Finish	7	Mounting	8
UNV 347V ¹	Universal (120/277V) 347V	DB Standard 0-10V 1% DB.1% 0-10V 0.1% ELV ² Reverse Phase 1% (120V only) TRI ² Forward phase (120V only) LDE1 Lutron Digital EcoSystem DALI DALI-2 Driver PoE Power over ethernet TW10 Dual channel, 0-10V for tunable white. WD10 0-10V Warm Dim PSQ Lutron T-Series 2-channel 1% for tunable white DMX ¹ DMX512		W White BLK Black SLV Silver CC ¹ Custom Color CWF ¹ Custom Wood Finish		T 9/16" Tee Grid T15 15/16" Tee Grid SG Slot Grid/Interlude F Flange NT Mud-in Flange PM-X Perimeter Mount MW ² Millwork	
*Must use DB Driver		¹ Set to default address 001. Contact us for other addressing needs. All DMX drivers provided in remote enclosures. ² For compatible dimmers, click here .		¹ Custom Color. See finish options here . White SJ cord and canopy provided; for other requests, see section 12 to specify.		¹ X' denotes mounting type on opposite side of wall (eg PM-NT). ² Consult Factory	
Optics	9	Sensors/Controls	10	Circuit	11	Options	12
POL	1" Drop Below Lens	NA None EIS Enlighted sensor WISM Wattstopper occupancy sensor WISD Wattstopper daylight sensor ACM Acuity nLight module only ACS Acuity nLight sensor CCS Casambi module AWN Lutron Athena Wireless Node Module		NA None EMPCK Emergency Battery Pack EMCKT Emergency Circuit DAYCKT Daylight Circuit		NA None WH 6ft whips preinstalled CP Chicago Plenum	
		Consult factory for other options.					

Performance

Output ¹	Watts/ft	Lumens/ft
Low	5	411
Medium	7	572
High	10	782

¹Based on a typically configured 90 CRI, 3500K luminaire using one driver.

Custom outputs available. Please consult factory.
 For 4000K multiply by 1.05, for 3000K 0.9%, for 2700K, 0.92

Technical Information



click [here](#) or scan QR code

Wiring diagrams, PoE and sensor details

Modification date: January, 2023

Page 2 of 4

LSR3 Pop Out Lens recessed

Drivers & Electrical

Integral drivers* with 0-10V Dimming standard. Several other driver options available; see ordering information.

*DMX drivers are provided in remote enclosures.

Sensors & Controls

Sensors are installed on an aluminum plate adjacent to the luminaire lens. Coronet remains agnostic in our approach to sensors and control systems; our fixtures are compatible with most systems offered.

*Not applicable to indirect only models. Consult factory.

Emergency Back-Up

For fixtures three-feet or longer, a 4W integral emergency driver may be wired to 4ft sections. 7W, 10W, and 12W drivers are also available (not all integral; consult factory). Emergency circuits for use with building generators are also available.

PoE (Power over Ethernet)

Compatible with virtually all PoE systems including Molex Coresync, Igor, Smartengine, Platformatics, and NuLED SPICEbox. Consult Factory for systems not listed, See [here](#) for more info.

Finishes

All luminaires are finished in high quality polyester powder coating. Our standard color is white. Any RAL color may be specified.

Weight

5 lbs per foot

Patterns

Featuring illuminated welded corners and angles. Consult factory for custom designs.

Optics

Extruded satin acrylic lenses provide excellent diffusion, high transmission, and no LED imaging.

Construction

Housings are extruded premium, recycled aluminum. Individual fixtures are available up to 12' long and may be specified as nominal or precision lengths. Precision lengths are supplied within 1/8" tolerance.

Joined Runs

Runs of any length may be specified and are comprised of multiple, factory-engineered, joined sections. Individually specified luminaires are not field joinable.

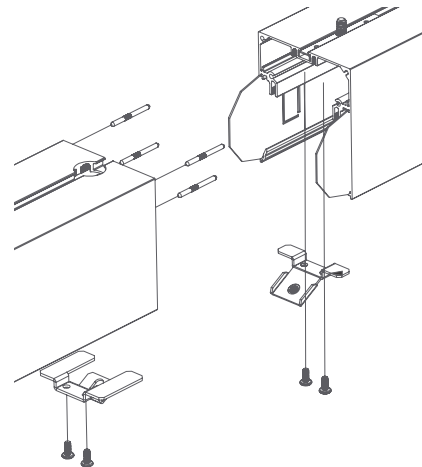

Representative joinery. For product specific details see installation guides or submittal drawings.

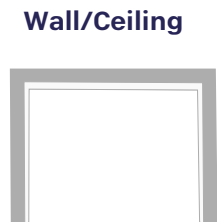
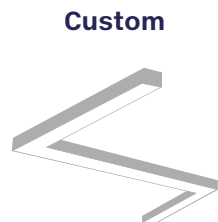
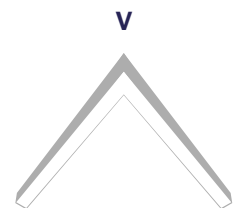
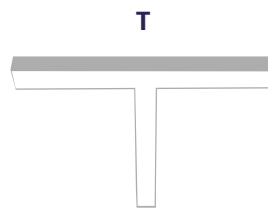
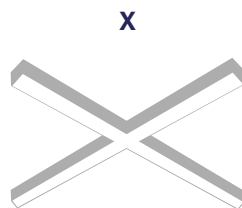
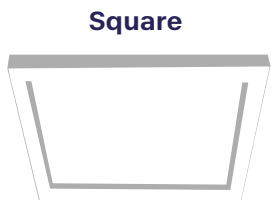

LSR3 Pop Out Lens recessed

Mounting Options

Custom mounting types and ceiling transitions available; consult factory.

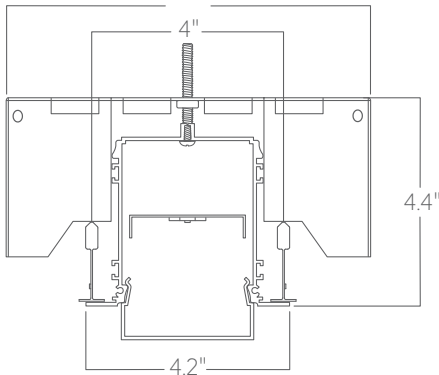

T
9/16" tee grid

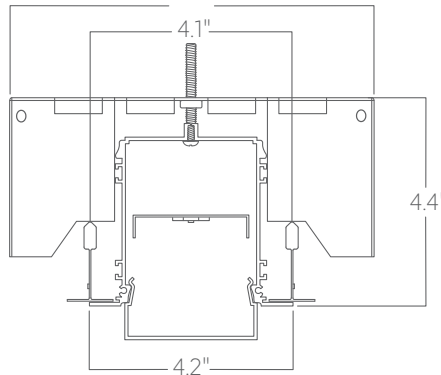

T15
15/16" tee grid

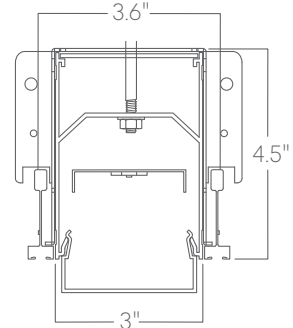

SG
slot grid

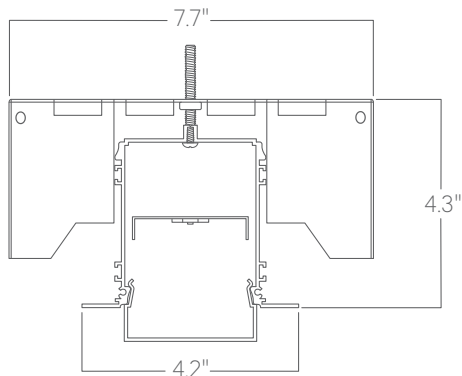

F
flange

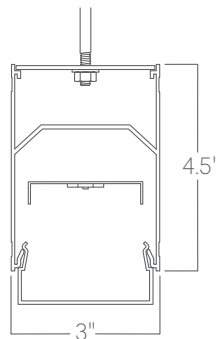

MW
millwork

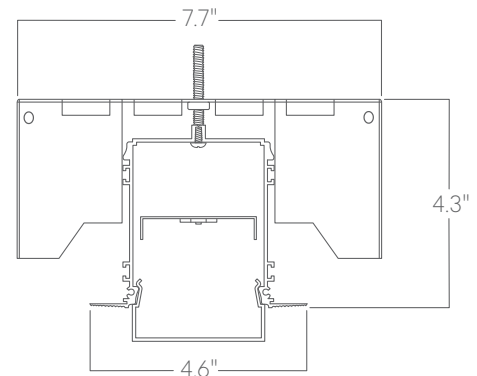

NT
mud-in¹

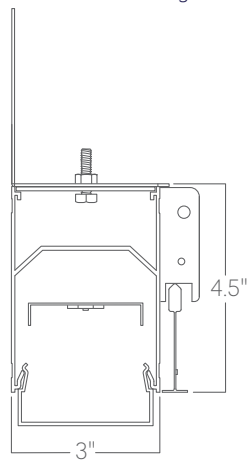

PM-T
perimeter to 9/16" tee grid

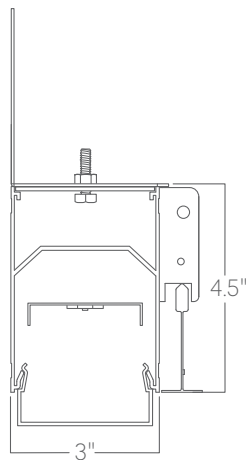

PM-T15
perimeter to 15/16" tee grid

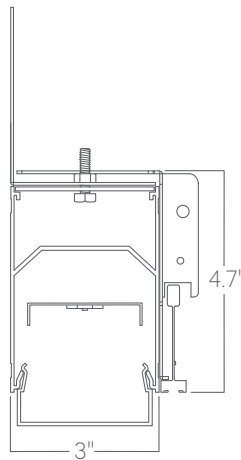

PM-SG
perimeter to slot grid

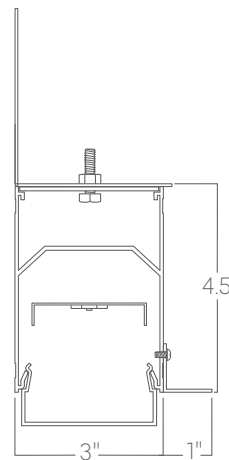

PM-F
perimeter to flange

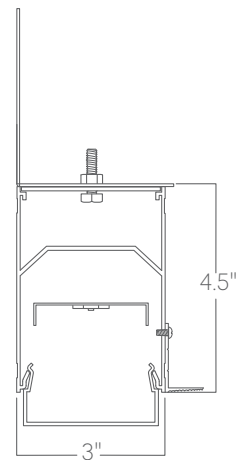

PM-NT
perimeter to mud-in

¹Installation that alters aperture width compromises lens security. Installer must ensure aperture width is maintained.