

LS4 MR direct

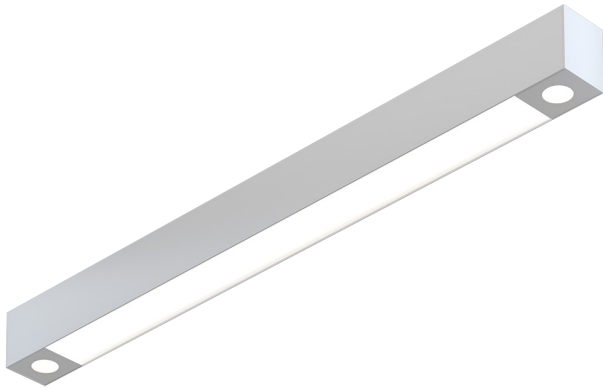

The LS Series of architectural luminaires offers a wide range of profiles and mounting options. Custom lengths and patterns are tailored to suit any modern space.

Features

- Extruded recycled aluminum housing
- Aluminum core LED boards, specifiable optics
- Specifiable color temperature. CRI > 90, R9 > 50
- Custom lengths, welded patterns, and finishes available
- Integral specifiable dimmable drivers or PoE
- 5 Year, 50,000 hour warranty, damp location rated
- Compatible with all wood ceilings
- WELL Building Standard compatible [learn more](#)

Dimensions

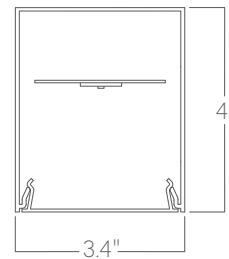

Optics

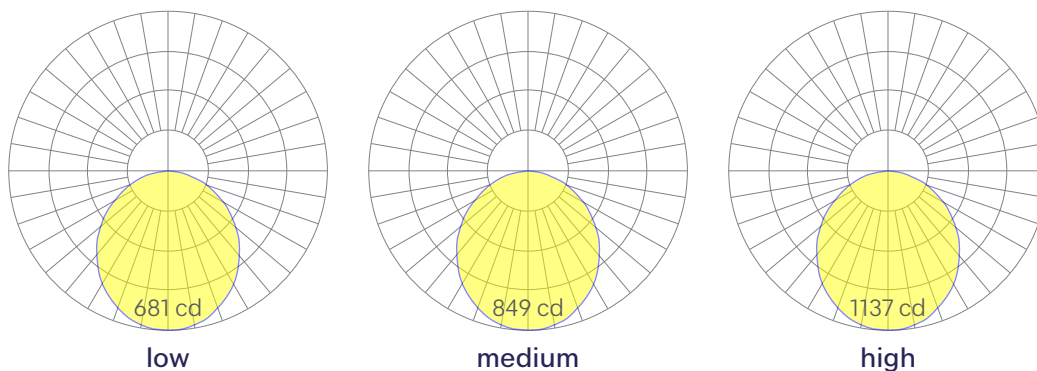

Representative distribution and peak candela. For other options see order information or IES files [here](#).

LS4 MR direct

Ordering Information

For each option group below specify one option. If you don't see your preferred option listed, contact us for [help](#).

1	Fixture ID	2	Length	3	Color Temperature	4	Output
	LS4 MR	2	2 ft	27	2700K/90 CRI	LOW	Low output
		4	4 ft	30	3000K/90 CRI	MED	Medium output
		8	8 ft	35	3500K/90 CRI	HIGH	High output
		X'-X"	Specify Length	40	4000K/90 CRI	CUST	Custom output Specify Watts or lumens
		PAT	Pattern (Consult Factory)	50	5000K/90 CRI		
				WD	Warm Dim 2200K-3000K Must use WD10 driver		
				TW	Tunable White 2700K-6500K Must use WD10 or PSQ driver		
				RGBW30	RGB +white, 3000k Remote DMX. High output unavailable.		
				RGBW35	RGB +white, 3500k Remote DMX. High output unavailable.		
				RGBW40	RGB +white, 4000k Remote DMX. High output unavailable.		
5	Voltage	6	Driver	7	Finish	8	Mounting
UNV	Universal (120/277V)	DB	Standard 0-10V 1%	W	White	AC	Aircraft cable (50")
347V	347V Available for DB Driver only	DB.1%	0-10V 0.1%	BLK	Black	ACTB9	Aircraft cable, Tbar clip, 9/16"
		ELV	Reverse Phase 1% (120V only) For compatible dimmers, click here .	SLV	Silver	ACTB15	Aircraft cable, Tbar clip, 15/16"
		TRI	Forward phase (120V only) For compatible dimmers, click here .	CC	Custom Color See finish options here .	ACTBSG	Aircraft cable, Tbar clip, Slot Grid
		LDE1	Lutron Digital EcoSystem	CWF	Custom Wood Finish See finish options here .	AC3.5	3.5" canopy + Jbox adaptor adaptor must be mudded-in.
		JA8	JA8 compliant 1% dimming			ACCC	Aircraft cable to Conduit Pipe Canopy
		DALI	DALI-2 Driver			PS-X	Pendant stem (12", 18", 24", 36", 48")
		PoE	Power over ethernet.			SMHC	Surface Mount, Hard Ceiling
		TW10	2 ch, 0-10V for tunable white.			SMTB9	Surface Mount, Tbar Clip, 9/16"
		WD10	0-10V Warm Dim			SMTB15	Surface Mount, Tbar Clip, 15/16"
		PSQ	Lutron T-Series 2-channel 1% For tunable white			SMTBSG	Surface Mount, Tbar Clip, Slot Grid
		DMX	DMX512 All DMX drivers set to default address 001 and provided in remote enclosers. Contact us for other addressing needs.			WM	Wall Mount
9	Optics	10	Sensors/Controls	11	Circuit	12	Options
FL	Flat diffuser	NA	None	NA	None	10° STD	10° standard beam MR
AVI ASY	Asymetric optic	EIS	Enlighted sensor	DC	Dual Circuit (separate linear and downlight control) May require additional power feeds.	25° CRC	25° circular beam MR
WW	Wall wash	WISM	Wattstopper occupancy	EMPCK	Emergency battery pack May require additional power feeds.	36° CRC	36° circular beam MR
		WISD	Wattstopper daylight	EMCKT	Emergency circuit May require additional power feeds.	60° CRC	60° circular beam MR
		ACM	Acuity nLight® module only	DAYCKT	Daylight circuit May require additional power feeds.	60° LNR	60° LNR 10°x60° linear beam
		ACS	Acuity nLight®			HEX	Hexcell louver Available for all beam spreads.
		CCS	Casambi module				
		AWNRR	Lutron Athena Wireless Node Module				
		AWNS	Lutron Athena Wireless Sensor Module				
		OTHER	Consult Factory				

Performance

Output ¹	Watts/ft	Lumens/ft	LPW
Low	5	494	91
Medium	7	598	85*
High	10	758	76

¹Based on a typically configured 90 CRI, 3500K luminaire using one driver.
Custom outputs available. Please consult factory.

For 4000K multiply by 1.05; for 3000K, 0.9; for 2700K, 0.92.

*80 CRI equivalent 100 LPW

Technical Information



click [here](#) or scan QR code

Wiring diagrams, PoE and sensor details

LS4 MR direct

Drivers & Electrical

Integral drivers* with 0-10V Dimming standard. Several other driver options available; see ordering information.

*DMX drivers are provided in remote enclosures.

Sensors & Controls

Sensors are installed on an aluminum plate adjacent to the luminaire lens¹. Coronet remains agnostic in our approach to sensors and control systems; our fixtures are compatible with most systems offered.

¹Not applicable to indirect only models. Consult factory.

Emergency Back-Up

For fixtures three-feet or longer, a 4W integral emergency driver may be wired to 4ft sections. 7W, 10W, and 12W drivers are also available (not all integral; consult factory). Emergency circuits for use with building generators are also available.

PoE (Power over Ethernet)

Compatible with virtually all PoE systems including Moxel Coresync, Igor, Smartengine, Platformatics, and NuLED SPICEbox.

Consult factory for systems not listed. See [here](#) for more info.

Finishes

All luminaires are finished in high quality polyester powder coating. Our standard color is white. Any RAL color may be specified.

Weight

5 lbs per foot

Patterns

Featuring illuminated welded corners and angles. Consult factory for custom designs and elevations.

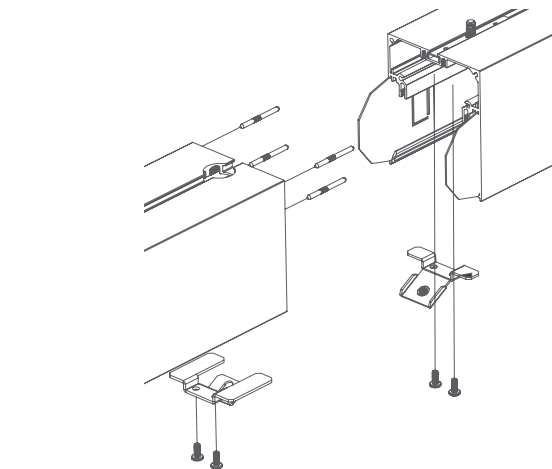
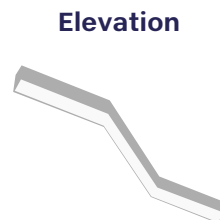
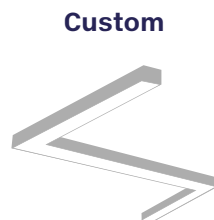
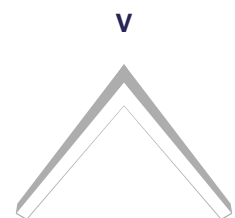
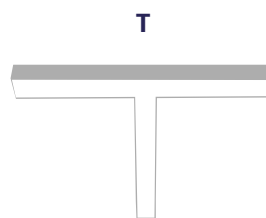
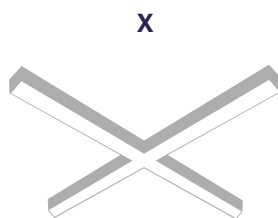
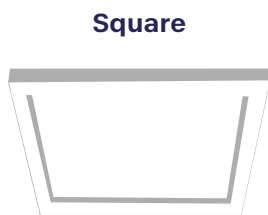

Representative joinery. For product specific details see installation guides or submittal drawings.

Optics

Extruded satin acrylic lenses provide excellent diffusion, high transmission, and no LED imaging.

Construction

Housings are extruded premium, recycled aluminum. Individual fixtures are available up to 12' long and may be specified as nominal or precision lengths. Precision lengths are supplied within 1/8" tolerance.

Joined Runs

Runs of any length may be specified and are comprised of multiple, factory-engineered, joined sections. Individually specified luminaires are not field joinable.

LS4 MR direct

Mounting Options

Custom mounting types and ceiling transitions available; consult factory.

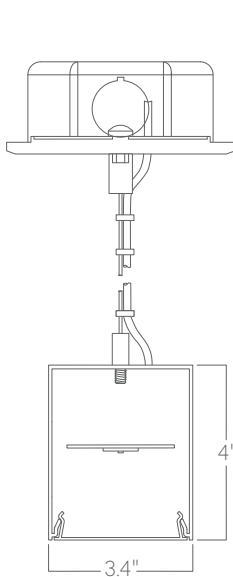

**Aircraft cable
5" canopy**

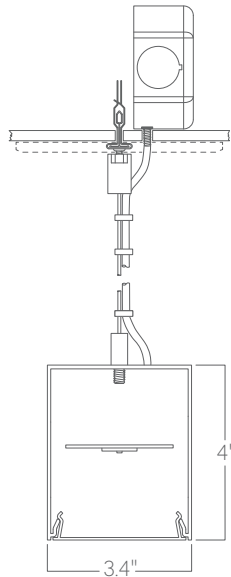

**Aircraft cable
5" canopy, T Bar clip**

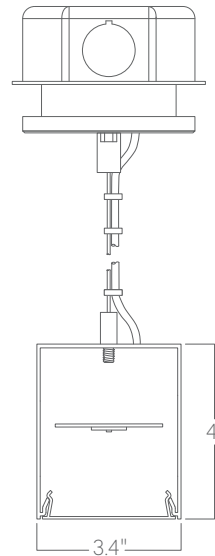

**Aircraft cable
3.5" canopy**

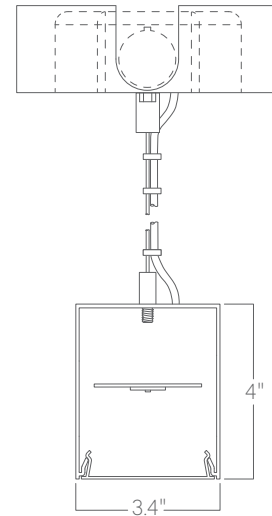

**Aircraft cable
Conduit canopy
with knockouts**

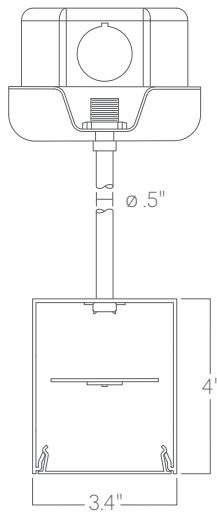

Pendant stem

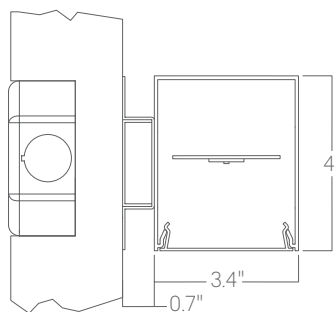

Wall mount

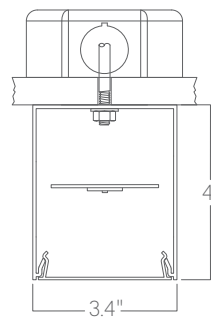

**Surface mount
Hard ceiling**

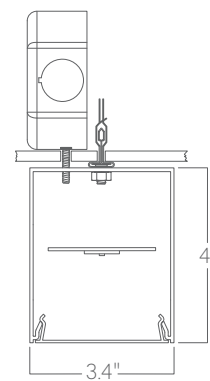

**Surface mount
T Bar clip**

Please consult factory shop drawings for suspension points.

To prevent damage to fixtures, factory designated suspension points must not be field altered.

Do not attempt installation if you do not understand the installation instructions.

LS4 MR direct

ACCENT LED Downlight Information

SORAA MR16, 95CRI LED lamps are provided with optional filters for flexible beam spread. Please note that when choosing a color temperature of 3500K, it will be a 4000K lamp with a color correcting filter supplied to achieve the specified color temperature.

Optional Beam Spreads and Filters

- 10° Standard Lens
- 25° Circular Beam Spread*
- 36° Circular Beam Spread*
- 60° Circular Beam Spread*
- 10° x 60° Linear Beam Spread*
- Hexcell Louver for Reduced Glare (can be added to any beam spread)*

*Standard 10° SORAA lamp is supplied with specially designed snap-in filter to create requested beam spread.

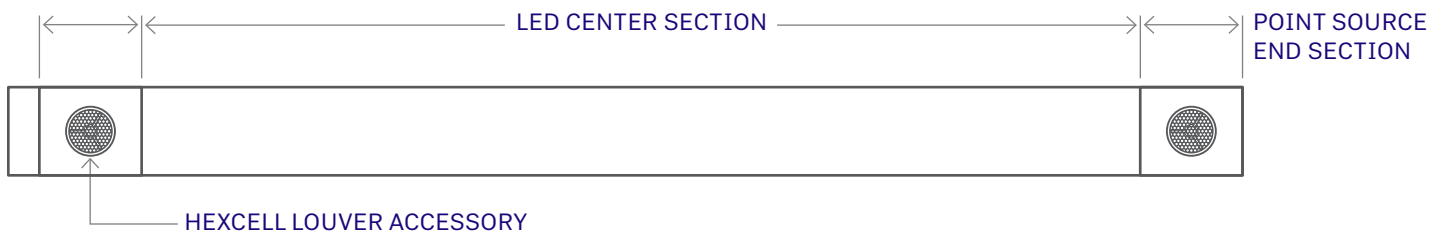
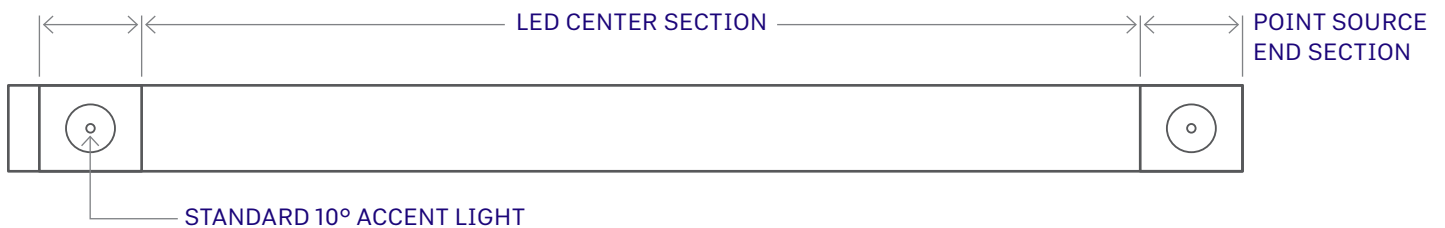

Please note: On individual fixtures, accent lights are placed on either end of the unit. For continuous runs, accent lights are placed every 8 feet. Consult Factory for alternative placement. Fixture must be a minimum of 4 feet.