

Quad 3ft direct

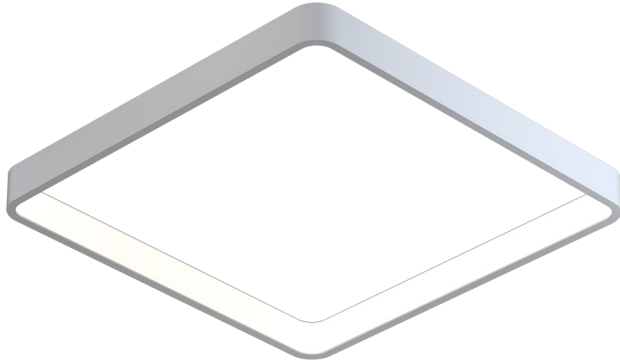

Our Performance Decorative luminaires offer a variety of decorative forms and sizes suitable for any modern space.

Features

- Power Over Wire system eliminates power cord
- Indirect and direct light distribution
- Specifiable color temperature. CRI > 90, R9 >50
- Custom colors and wood finishes finishes available
- Specifiable dimmable drivers or PoE
- 5 Year, 50,000 hour warranty, damp location rated
- WELL Building Standard compatible [learn more](#)

Dimensions

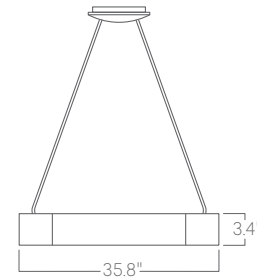

Optics

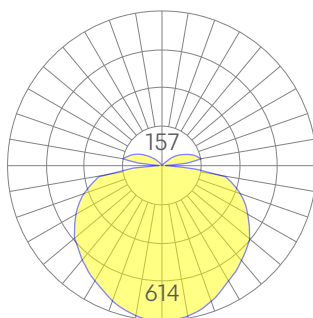

low

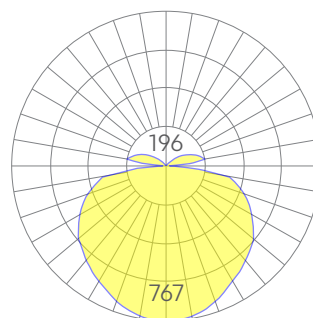

medium

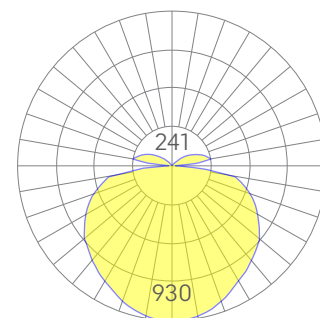

high

Representative distribution and peak candela. For other options see order information or IES files [here](#).

Quad 3ft direct

Ordering Information

1 - 2 - 3 - 4 - 5 - 6 - 7 - 8 - 9 - 10 - 11 - 12

Example: QUAD 3 - 35 - MED - UNV - DB - W - ACP - SD - CCS - DAYCKT - NA

Fixture ID 1	Length 2	Color Temperature 3	Output 4
QUAD	3 3 ft	27 2700K/90 CRI 30 3000K/90 CRI 35 3500K/90 CRI 40 4000K/90 CRI	LOW Low output MED Medium output HIGH High output CUST Custom output ¹
Voltage 5	Driver 6	Finish 7	Mounting 8
UNV Universal (120/277V) 347V¹ 347V	DB Standard 0-10V 1% DB.1% 0-10V 0.1% ELV² Reverse Phase 1% (120V only) TRI² Forward phase (120V only) LDE1 Lutron Digital EcoSystem DALI DALI-2 Driver PoE Power over Ethernet. DMX¹ DMX512	W White BLK Black SLV Silver CC¹ Custom Color CWF¹ Custom Wood Finish	ACP Power Over Aircraft Cable SM Surface Mount
¹ Must use DB Driver	¹ Set to default address 001. Contact us for other addressing needs. ² For compatible dimmers, click here .	¹ Custom Color. See finish options here . White SJ cord and canopy provided; for other requests, see section 12 to specify.	White canopy provided. Must specify other requests.
Optics 9	Sensors/Controls 10	Circuit 11	Options 12
SD Standard Diffuser	NA None ACM Acuity nLight Module Only CCS Casambi Module AWNRR Lutron Athena Wireless Node Module	NA None EMPCK Emergency Battery Pack EMCKT Emergency Circuit DAYCKT Daylight Circuit	STD White Canopy + White Cord CAN-X¹ Canopy + Color SJ-X² SJ Cord + Color FC³ Flat Canopy
	Consult factory for other options.		¹ See finish options here . ² SJ Cord only available in White or Black. ³ Remote drivers only

Performance

Output ¹	Watts	Lumens
Low	28	2784
Medium	36	3475
High	45	4214

¹Based on a typically configured 90 CRI, 3500K luminaire using one driver.

Custom outputs available. Please consult factory.
For 4000K multiply by 1.05, for 3000K 0.96, for 2700K, 0.92.

Technical Information



click [here](#) or scan QR code

Wiring diagrams, PoE and sensor details

Modification date: February 2023

Page 2 of 3

Quad 3ft direct

Drivers & Electrical

Our Power Over Wire system delivers power to the luminaire via suspension cables, eliminating a separate power feed. Drivers are housed in the luminaire canopy or in factory supplied remote enclosures¹. All drivers are dimmable. For remote driver box sizes, click [here](#).

¹See order information for more details.

Emergency Back-Up

Emergency, battery-powered drivers are available. Emergency circuits for use with building generators are also available.

PoE (Power over Ethernet)

Compatible with virtually all PoE systems including Molex Coresync, Igor, Smartengine, Platformatics, and NuLED SPICEbox. Consult Factory for systems not listed. See [here](#) for more info.

Weight

13 lbs

Mounting

Optics

Extruded satin acrylic lenses provide excellent diffusion, high transmission, and no LED imaging.

Construction

Welded, extruded, recycled aluminum.

Finishes

All luminaires are finished in high quality polyester powder coating. Our standard color is white. Any RAL color may be specified.

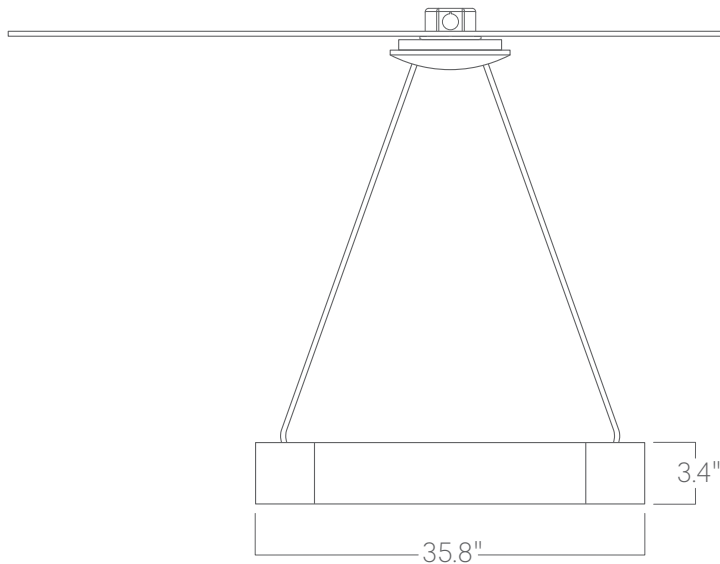

Power over aircraft cable

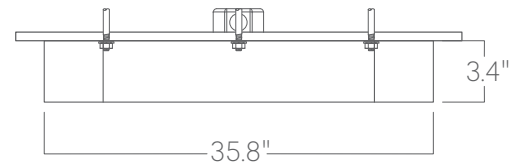

Surface mount