

INSTALLATION GUIDE-GRID

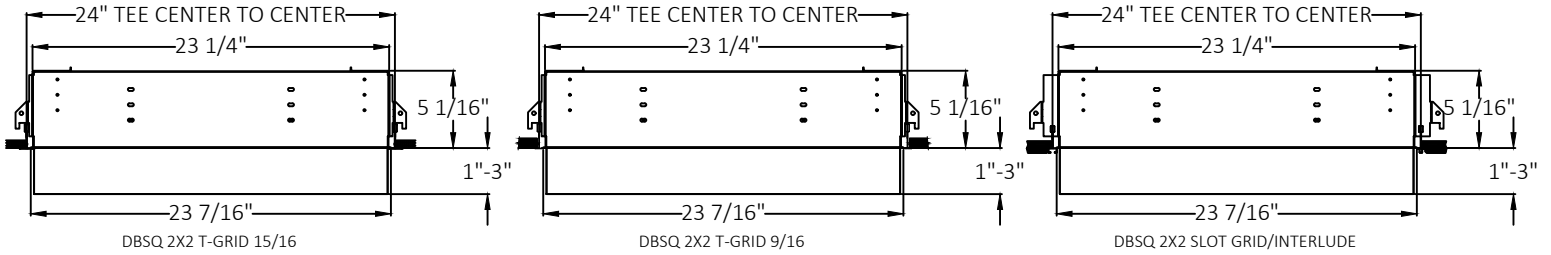

Risk of fire and electrical shock. In accordance with national local building and electrical codes, CORONET lighting fixtures must be installed by a qualified electrician. Disconnect power at electrical panel before servicing.

CROSS SECTION VIEW



ISOMETRIC VIEW

PART LIST

- A-Drop Lens
- B-Housing

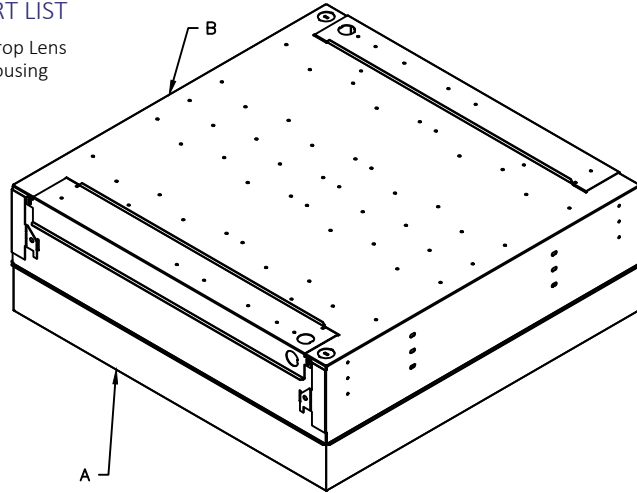

1

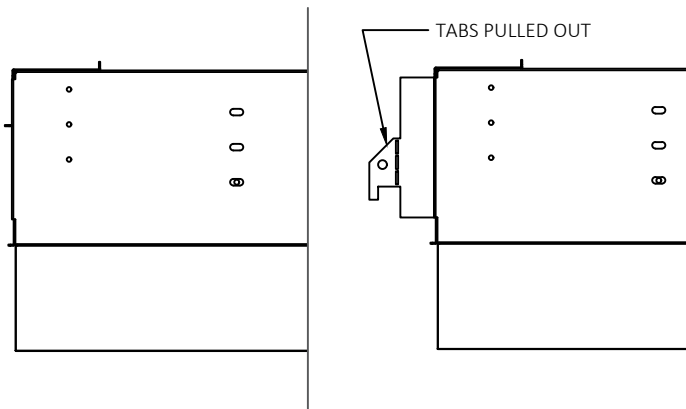

Before installing into the grid, pull out the tabs at all four corners of the housing.

2

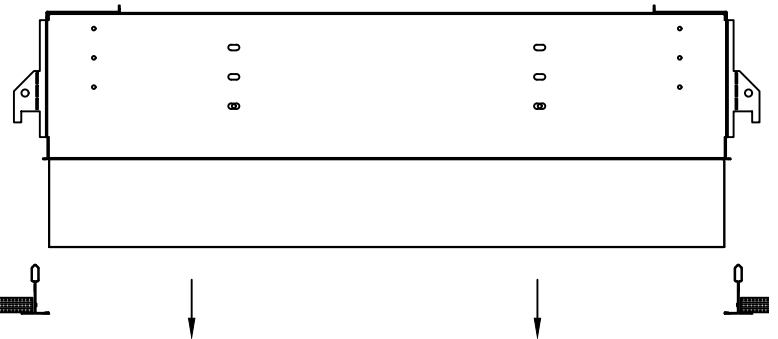

Install the fixture into the ceiling using a 1/4-20 machine screw and nut (hardware by others).

INDIVIDUAL FIXTURES ARE NOT INTENDED FOR CONTINUOUS RUNS.  
ADDITIONAL SUPPORTS TO THE STRUCTURE MAY BE REQUIRED.  
CHECK WITH YOUR LOCAL BUILDING CODE FOR THOSE REQUIREMENTS.

INSTALLATION GUIDE-GRID



Risk of fire and electrical shock. In accordance with national local building and electrical codes, CORONET lighting fixtures must be installed by a qualified electrician. Disconnect power at electrical panel before servicing.

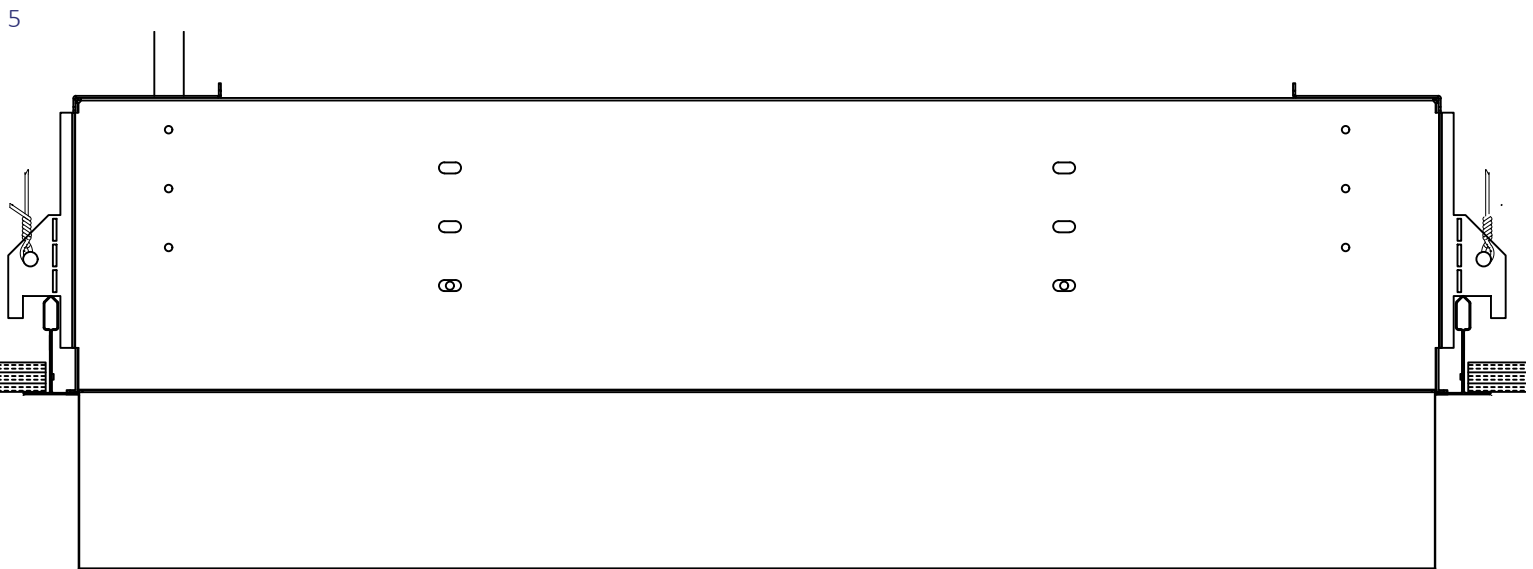
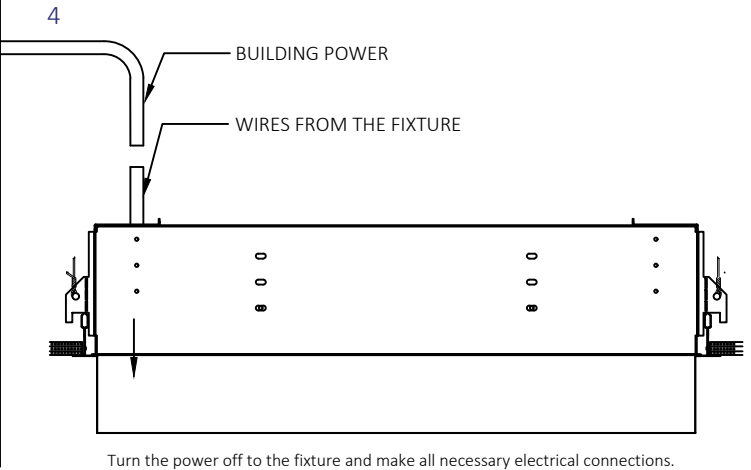
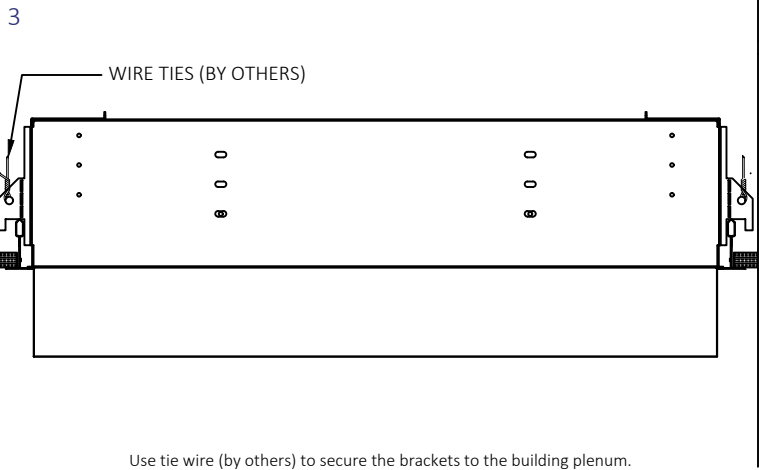

Power on the fixture to make sure everything works properly.

**GENERAL INSTALLATION CONSIDERATIONS** - See submittal drawings for job specific data.

Operating Temperature.....-40°C to 50°C  
 Operating Voltage.....110VAC-277VAC, 50Hz-60Hz  
 Weight.....N/A  
 Dimensions.....See submittal drawings

- Installation by a certified electrician only.
- Read and understand the installation instructions before attempting to install or use the fixture.
- Only use fixtures with voltage for which it is rated. Do not exceed the specified voltage and current input.
- Do not use the fixture if the housing, lens, or power cable is damaged.
- Ensure that the main power supply is off before installing or wiring the fixture.
- Method of wire connection to be determined by local electrical codes and regulations.
- The external flexible cable of this luminaire cannot be field replaced; if the cord is damaged, contact Coronet.
- The light source contained in this luminaire shall only be replaced by the lighting manufacturer or his service agent or a similar qualified person.

Please contact our technical support team for assistance.

NOTE: JUNCTION BOXES MUST BE SOLIDLY FIXED TO THE CEILING AND ATTACHED TO THE STRUCTURAL MEMBER INSIDE THE CEILING BEFORE PROCEEDING WITH INSTALLATION.