

RRD 2ft recessed



Our Performance Decorative luminaires offer a variety of decorative forms and sizes suitable for any modern space.

Features

- Cold-rolled steel housing
- Specifiable color temperature. CRI > 90, R9 >50
- Integral, specifiable dimmable drivers or PoE
- Custom colors and wood finishes finishes available
- 5 Year, 50,000 hour warranty, damp location rated
- WELL Building Standard compatible [learn more](#)

Dimensions

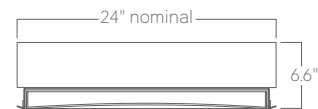

Optics

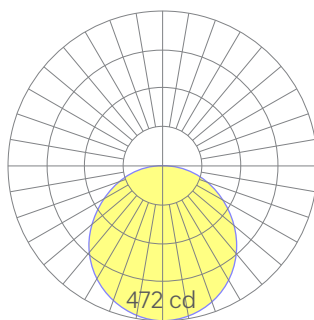

low

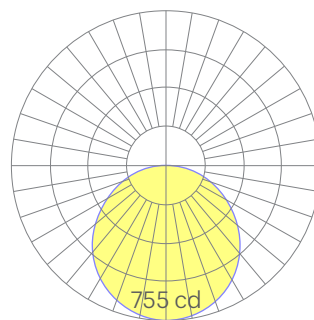

medium

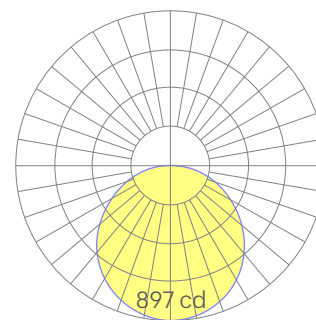

high

Representative distribution and peak candela. For other options see order information or IES files [here](#).

RRD 2ft recessed

Ordering Information

For each option group below specify one option. If you don't see your preferred option listed, contact us for [help](#).

1	Fixture ID	2	Size	3	Color Temperature	4	Output
	RRD	2	2 ft	27	2700K/90 CRI	LOW	Low output
				30	3000K/90 CRI	MED	Medium output
				35	3500K/90 CRI	HIGH	High output
				40	4000K/90 CRI	CUST	Custom output Specify Watts or lumens
				50	5000K/90 CRI		
				WD	Warm Dim 2200K-3000K Must use WD10 driver.		
				TW	Tunable White 2700K-6500K Must use TW10 or PSQ driver.		
5	Voltage	6	Driver	7	Finish	8	Mounting
UNV	Universal (120/277V)	DB	Standard 0-10V 1%	W	White	T	9/16" Tee Grid
347V	347V Available for DB Driver only	DB.1%	0-10V 0.1%	BLK	Black	T15	15/16" Tee Grid
		ELV	Reverse Phase 1% (120V only) For compatible dimmers see here .	SLV	Silver	SG	Slot Grid/Interlude
		TRI	Forward phase (120V only) For compatible dimmers see here .	CC	Custom Color See finish options here .	SR	Sheetrock
		LDE	Lutron Digital EcoSystem	CWF	Custom Wood Finish See finish options here .		
		DALI	DALI-2 Driver				
		PoE	Power over ethernet.				
		TW10	Dual channel, 0-10V for tunable white.				
		WD10	0-10V Warm Dim				
		PSQ	Lutron T-Series 2-channel 1% for tunable white				
		DMX	DMX512 All DMX drivers set to default address 001 and provided in remote enclosers. Contact us for other addressing needs				
9	Optics	10	Sensors/Controls	11	Circuit	12	Options
SD	Standard Diffuser	NA	None	NA	None	NA	None
DL	1/2" Drop Lens	ACM	Acuity nLight Module Only	EMPCK	Emergency battery pack May require additional power feeds.	WH6	6ft whips preinstalled
		CCS	Casambi Module	EMCKT	Emergency circuit May require additional power feeds.		
		AWNRR	Lutron Athena Wireless Node Module	DAYCKT	Daylight circuit May require additional power feeds.		
		OTHER	Consult Factory				

Performance

Output ¹	Watts	Lumens
Low	20	1366
Medium	32	2186
High	38	2596

¹Based on a typically configured 90 CRI, 3500K luminaire using one driver. Custom outputs available. Please consult factory. For 4000K multiply by 1.05, for 3000K, 0.96, for 2700K, 0.92.

Technical Information



click [here](#) or scan QR code

Wiring diagrams, PoE and sensor details

RRD 2ft recessed

Drivers & Electrical

Integral drivers* with 0-10V Dimming standard. Several other driver options available; see ordering information.

*DMX drivers are provided in remote enclosures.

Emergency Back-Up

Emergency, battery-powered drivers are available. Emergency circuits for use with building generators are also available.

PoE (Power over Ethernet)

Compatible with virtually all PoE systems including Molex Coresync, Igor, Smartengine, Platformatics, and NuLED SPICEbox. Consult Factory for systems not listed, See [here](#) for more info.

Weight

10 lbs

Mounting

Optics

Custom opal lens provides excellent diffusion, high transmission, and no LED imaging.

Construction

Cold-rolled steel.

Finishes

All luminaires are finished in high quality polyester powder coating. Our standard color is white. Any RAL color may be specified.

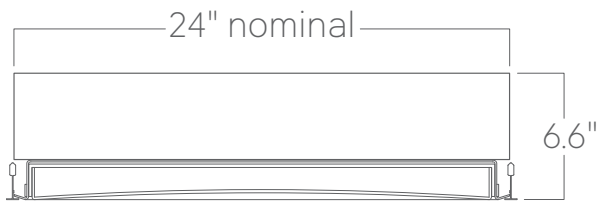

T
9/16" tee grid

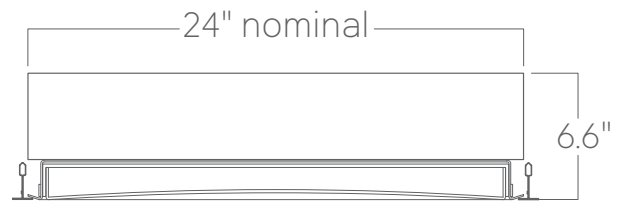

T15
15/16" tee grid

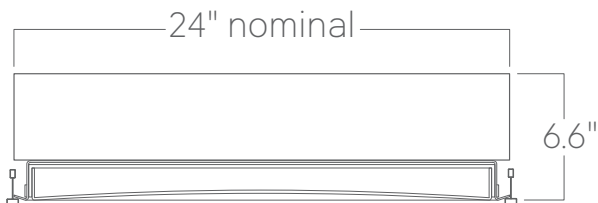

SG
slot grid/interlude

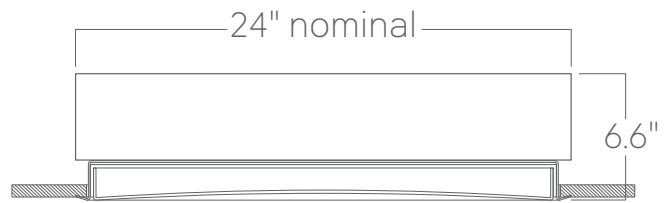

SR
sheetrock