

# LS6 direct



The LS Series of architectural luminaires offers a wide range of profiles and mounting options. Custom lengths and patterns are tailored to suit any modern space.

## Features

- Extruded recycled aluminum housing
- Aluminum core LED boards, specifiable optics
- Specifiable color temperature. CRI > 90, R9 >50
- Custom lengths, welded patterns, and finishes available
- Integral specifiable dimmable drivers or PoE
- 5 Year, 50,000 hour warranty, damp location rated
- WELL Building Standard compatible [learn more](#)

## Dimensions

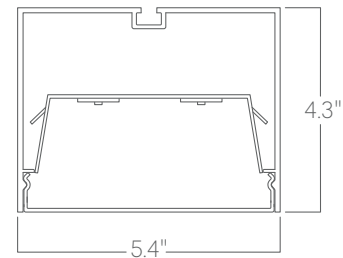

## Optics

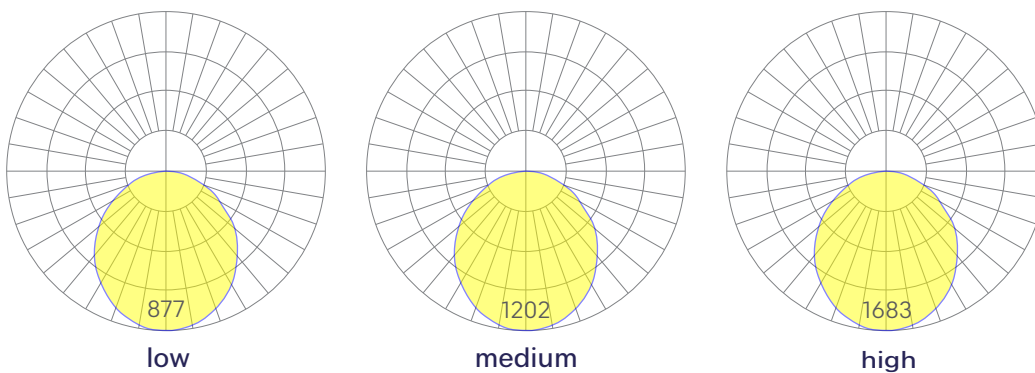

Representative distribution and peak candela. For other options see order information or IES files [here](#).

# LS6 direct

## Ordering Information



Example: LS6 - 8 - 35 - MED - UNV - DB - W - AC - FL - CCS - DAYCKT - NA

Fixture ID	1	Length	2	Color Temperature	3	Output	4
LS6		<b>2</b> 2 ft <b>4</b> 4 ft <b>8</b> 8 ft <b>X'-X"</b> Specify Length <b>PAT</b> Pattern (Consult Factory)		<b>27</b> 2700K/90 CRI <b>30</b> 3000K/90 CRI <b>35</b> 3500K/90 CRI <b>40</b> 4000K/90 CRI <b>50</b> 5000K/90 CRI  <b>WD<sup>1</sup></b> Warm Dim 2200K-3000K <b>TW<sup>2</sup></b> Tunable White 2700K-6500K <b>RGBW30<sup>3</sup></b> RGB +white, 3000k <b>RGBW35<sup>3</sup></b> RGB +white, 3500k <b>RGBW40<sup>3</sup></b> RGB +white, 4000k		<b>LOW</b> Low output <b>MED</b> Medium output <b>HIGH</b> High output <b>CUST</b> Custom output <sup>1</sup>	
		*Precision lengths may be specified to the nearest 1/8".		<sup>1</sup> Must use WD10 driver. <sup>2</sup> Must use TW10 or PSQ driver. <sup>3</sup> Must use remote DMX driver. "High" output not available.		*consult factory	
Voltage	5	Driver	6	Finish	7	Mounting	8
UNV 347V <sup>1</sup>	Universal (120/277V) 347V	<b>DB</b> Standard 0-10V 1% <b>DB.1%</b> 0-10V 0.1% <b>ELV<sup>2</sup></b> Reverse Phase 1% (120V only) <b>TRI<sup>2</sup></b> Forward phase (120V only) <b>LDE1</b> Lutron Digital EcoSystem <b>JA8</b> JA8 compliant 1% dimming <b>DALI</b> DALI-2 Driver <b>PoE</b> Power over ethernet. <b>TW10</b> 2 ch, 0-10V for tunable white. <b>WD10</b> 0-10V Warm Dim <b>PSQ</b> Lutron T-Series 2-channel 1% for tunable white <b>DMX<sup>1</sup></b> DMX512		<b>W</b> White <b>BLK</b> Black <b>SLV</b> Silver <b>CC<sup>1</sup></b> Custom Color <b>CWF<sup>1</sup></b> Custom Wood Finish		<b>AC</b> Aircraft Cable (50") <b>AC3.5</b> 3.5" canopy + jbox adaptor <sup>1</sup> <b>ACPC</b> Aircraft cable to Conduit Pipe Canopy <b>SM</b> Surface Mount <b>WM</b> Wall Mount <b>PS-X</b> Pendant Stem (12", 18", 24", 36", 48")	
*Must use DB Driver		<sup>1</sup> Set to default address 001. Contact us for other addressing needs. All DMX drivers provided in remote enclosures. <sup>2</sup> For compatible dimmers, click <a href="#">here</a> .		<sup>1</sup> Custom Color. See finish options <a href="#">here</a> . White SJ cord and canopy provided; for other requests, see section 12 to specify.		<sup>1</sup> Adaptor must be mudded-in White stems and canopy provided unless otherwise specified in options (section 12).	
Optics	9	Sensors/Controls	10	Circuit	11	Options	12
FL Flat Diffuser		<b>NA</b> None <b>EIS</b> Enlightened sensor <b>WISM</b> Wattstopper occupancy sensor <b>WISD</b> Wattstopper daylight sensor <b>ACM</b> Acuity nLight module only <b>ACS</b> Acuity nLight sensor <b>CCS</b> Casambi module <b>AWNR</b> Lutron Athena Wireless Node Module		<b>NA</b> None <b>EMPCK</b> Emergency Battery Pack <b>EMCKT</b> Emergency Circuit <b>DAYCKT</b> Daylight Circuit		<b>STD</b> White Canopy + White Cord <b>CAN-X<sup>1</sup></b> Canopy + color <b>SJ-X<sup>2</sup></b> SJ Cord + color	
		Consult factory for other options.				<sup>1</sup> See finish options <a href="#">here</a> . <sup>2</sup> SJ Cord only available in White or Black.	

## Performance

Output <sup>1</sup>	Watts/ft	Lumens/ft
Low	7	611
Medium	9	838
High	13	1173

<sup>1</sup>Based on a typically configured 90 CRI, 3500K luminaire using one driver.

Custom outputs available. Please consult factory.  
 For 4000K multiply by 105, for 3000K 0.96, for 2700K, 0.92.

## Technical Information



click [here](#) or scan QR code

Wiring diagrams, PoE and sensor details

Modification date: February 2023

Page 2 of 4

# LS6 direct

## Drivers & Electrical

Integral drivers\* with 0-10V Dimming standard. Several other driver options available; see ordering information.

\*DMX drivers are provided in remote enclosures.

## Sensors & Controls

Sensors are installed on an aluminum plate adjacent to the luminaire lens<sup>1</sup>. Coronet remains agnostic in our approach to sensors and control systems; our fixtures are compatible with most systems offered.

<sup>1</sup>Not applicable to indirect only models. Consult factory.

## Emergency Back-Up

For fixtures three-feet or longer, a 4W integral emergency driver may be wired to 4ft sections. 7W, 10W, and 12W drivers are also available (not all integral; consult factory). Emergency circuits for use with building generators are also available.

## PoE (Power over Ethernet)

Compatible with virtually all PoE systems including Molex Coresync, Igor, Smartengine, Platformatics, and NuLED SPICEbox. Consult Factory for systems not listed, See [here](#) for more info.

## Finishes

All luminaires are finished in high quality polyester powder coating. Our standard color is white. Any RAL color may be specified.

## Weight

5 lbs per foot

## Patterns

Featuring illuminated welded corners and angles. Consult factory for custom designs and elevations.

## Optics

Extruded satin acrylic lenses provide excellent diffusion, high transmission, and no LED imaging.

## Construction

Housings are extruded premium, recycled aluminum. Individual fixtures are available up to 12' long and may be specified as nominal or precision lengths. Precision lengths are supplied within 1/8" tolerance.

## Joined Runs

Runs of any length may be specified and are comprised of multiple, factory-engineered, joined sections. Individually specified luminaires are not field joinable.



Representative joinery. For product specific details see installation guides or submittal drawings.

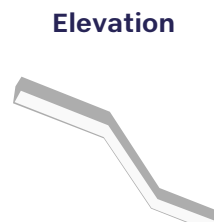
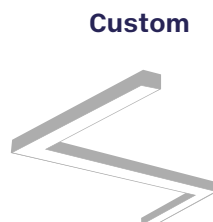
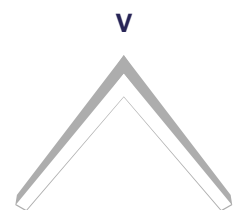
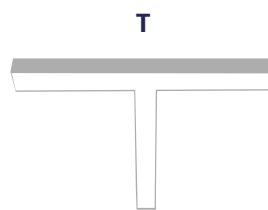
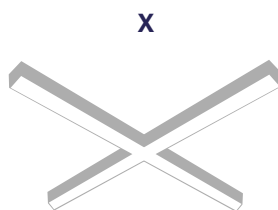
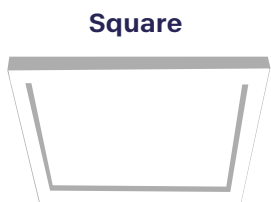

## Mounting Options

Custom mounting types and ceiling transitions available; consult factory.

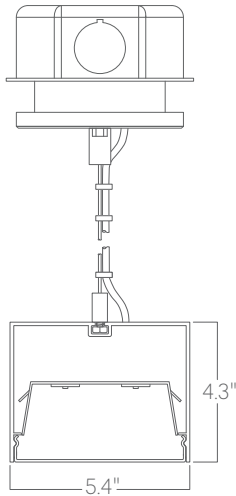

**Aircraft cable  
3.5" canopy**

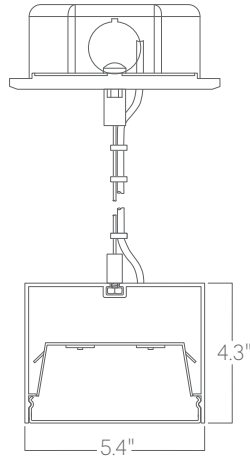

**Aircraft cable  
5" canopy**

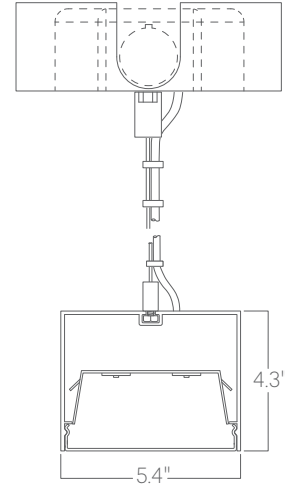

**Aircraft cable  
Conduit canopy  
with knockouts**

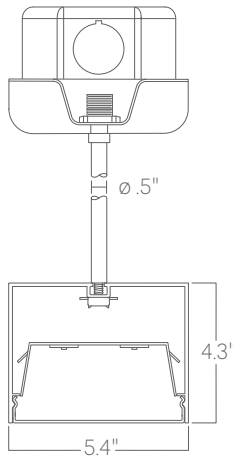

**Pendant stem**

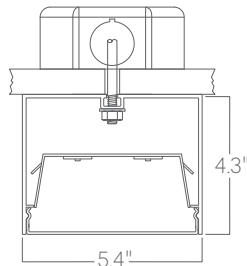

**Surface mount**

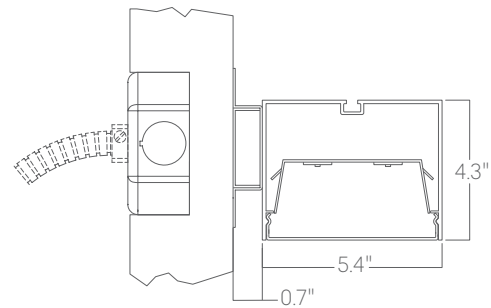

**Wall mount**