

LS2 Direct



The LS Series of architectural luminaires offers a wide range of profiles and mounting options. Custom lengths and patterns are tailored to suit any modern space.

Features

- Extruded recycled aluminum housing
- Aluminum core LED boards, specifiable optics
- Specifiable color temperature. CRI > 90, R9 >50
- Custom lengths, welded patterns, and finishes available
- Integral specifiable dimmable drivers or PoE
- 5 Year, 50,000 hour warranty, damp location rated
- WELL Building Standard compatible [learn more](#)

Dimensions

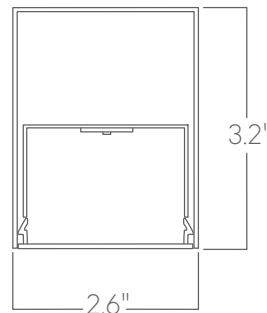

Flat Lens

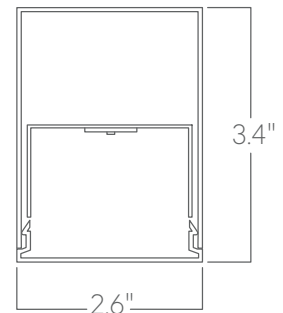

Reveal Lens

Optics

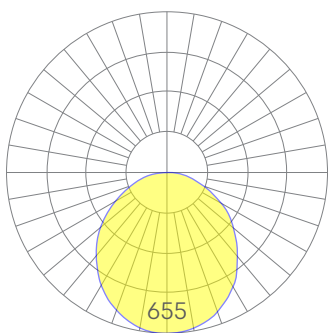

low

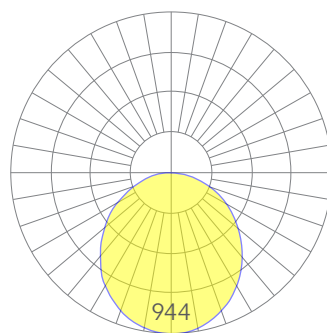

medium

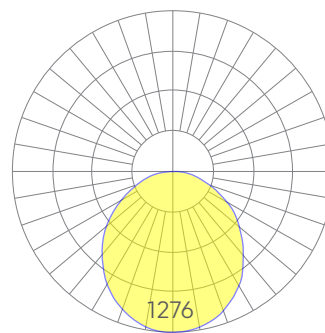

high

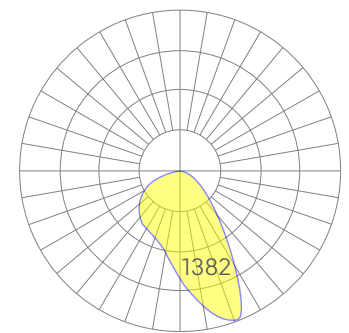

avi-asymmetric

Representative distribution and peak candela. For other options see order information or IES files [here](#).

LS2 Direct

Ordering Information



Example: LS2 - 8 - 35 - MED - UNV - DB - W - AC - FL - CCS - DAYCKT - NA

Fixture ID <input type="text" value="1"/>	Length <input type="text" value="2"/>	Color Temperature <input type="text" value="3"/>	Output <input type="text" value="4"/>
LS2	2 2 ft 4 4 ft 8 8 ft X'-X" Specify Length PAT Pattern (Consult Factory)	27 2700K/90 CRI 30 3000K/90 CRI 35 3500K/90 CRI 40 4000K/90 CRI 50 5000K/90 CRI WD¹ Warm Dim 2200K-3000K TW² Tunable White 2700K-6500K RGBW30³ RGB +white, 3000k RGBW35³ RGB +white, 3500k RGBW40³ RGB +white, 4000k	LOW Low output MED Medium output HIGH High output CUST Custom output ¹
<small>*Precision lengths may be specified to the nearest 1/8".</small>		<small>¹Must use WD10 driver. ²Must use TW10 or PSQ driver. ³Must use remote DMX driver. "High" output not available.</small>	
<small>¹consult factory</small>			
Voltage <input type="text" value="5"/>	Driver <input type="text" value="6"/>	Finish <input type="text" value="7"/>	Mounting <input type="text" value="8"/>
UNV Universal (120/277V) 347V¹ 347V	DB Standard 0-10V 1% DB.1% 0-10V 0.1% ELV² Reverse Phase 1% (120V only) TRI² Forward phase (120V only) LDE1 Lutron Digital EcoSystem JA8 JA8 compliant 1% dimming DALI DALI-2 Driver PoE Power over ethernet. TW10 2 ch, 0-10V for tunable white. WD10 0-10V Warm Dim PSQ Lutron T-Series 2-channel 1% for tunable white DMX¹ DMX512	W White BLK Black SLV Silver CC¹ Custom Color CWF¹ Custom Wood Finish	AC Aircraft Cable (50") AC3.5 3.5" canopy + jbox adaptor ¹ ACPC Aircraft cable to Conduit Pipe Canopy SM Surface Mount WM Wall Mount PS-X Pendant Stem (12", 18", 24", 36", 48")
<small>¹Must use DB Driver</small>		<small>¹Adaptor must be mudded-in White stems and canopy provided unless otherwise specified in options (section 12).</small>	
<small>¹Set to default address 001. Contact us for other addressing needs. All DMX drivers provided in remote enclosures. ²For compatible dimmers, click here.</small>		<small>¹Custom Color. See finish options here. White SJ cord and canopy provided; for other requests, see section 12 to specify.</small>	
Optics <input type="text" value="9"/>	Sensors/Controls <input type="text" value="10"/>	Circuit <input type="text" value="11"/>	Options <input type="text" value="12"/>
FL Flat Diffuser RV 0.2" Reveal Lens AVI ASY Flat, Asymmetric Lens	NA None EIS Enlighted sensor WISM Wattstopper occupancy sensor WISD Wattstopper daylight sensor ACM Acuity nLight module only ACS Acuity nLight sensor CCS Casambi module AWNR Lutron Athena Wireless Node Module	NA None EMPCK Emergency Battery Pack EMCKT Emergency Circuit DAYCKT Daylight Circuit	STD White Canopy + White Cord CAN-X¹ Canopy + color SJ-X² SJ Cord + color
<small>Consult factory for other options.</small>		<small>¹See finish options here. ²SJ Cord only available in White or Black.</small>	

Performance

Output ¹	Watts/ft	Lumens/ft	LPW
Low	5	476	95
Medium	7	646	92*
High	10	877	88

¹Based on a typically configured 90 CRI, 3500K luminaire using one driver. Custom outputs available. Please consult factory.
 For 4000K multiply by 1.05, for 3000K 0.96, for 2700K, 0.92

*80 CRI equivalent 109 LPW

Technical Information



click [here](#) or scan QR code

Wiring diagrams, PoE and sensor details

Modification date: February 2023

Page 2 of 4

LS2 Direct

Drivers & Electrical

Integral drivers* with 0-10V Dimming standard. Several other driver options available; see ordering information.

*DMX drivers are provided in remote enclosures.

Sensors & Controls

Sensors are installed on an aluminum plate adjacent to the luminaire lens¹. Coronet remains agnostic in our approach to sensors and control systems; our fixtures are compatible with most systems offered.

¹Not applicable to indirect only models. Consult factory.

Emergency Back-Up

For fixtures three-feet or longer, a 4W integral emergency driver may be wired to 4ft sections. 7W, 10W, and 12W drivers are also available (not all integral; consult factory). Emergency circuits for use with building generators are also available.

PoE (Power over Ethernet)

Compatible with virtually all PoE systems including Molex Coresync, Igor, Smartengine, Platformatics, and NuLED SPICEbox. Consult Factory for systems not listed, See [here](#) for more info.

Finishes

All luminaires are finished in high quality polyester powder coating. Our standard color is white. Any RAL color may be specified.

Weight

3 lbs per foot

Patterns

Featuring illuminated welded corners and angles. Consult factory for custom designs and elevations.

Optics

Extruded satin acrylic lenses provide excellent diffusion, high transmission, and no LED imaging.

Construction

Housings are extruded premium, recycled aluminum. Individual fixtures are available up to 12' long and may be specified as nominal or precision lengths. Precision lengths are supplied within 1/8" tolerance.

Joined Runs

Runs of any length may be specified and are comprised of multiple, factory-engineered, joined sections. Individually specified luminaires are not field joinable.

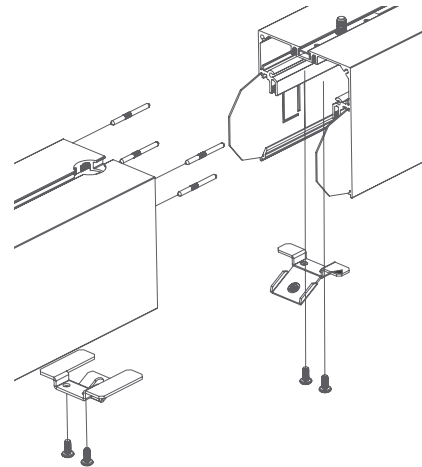

Representative joinery. For product specific details see installation guides or submittal drawings.

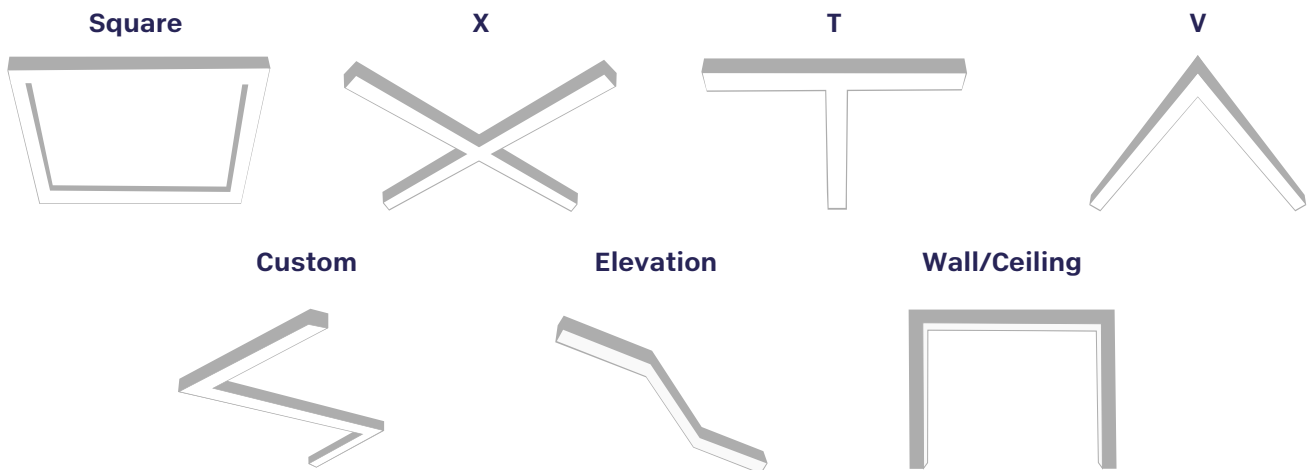

Mounting Options

Custom mounting types and ceiling transitions available; consult factory.

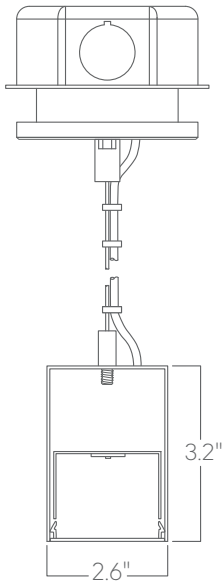

**Aircraft cable
3.5" canopy**

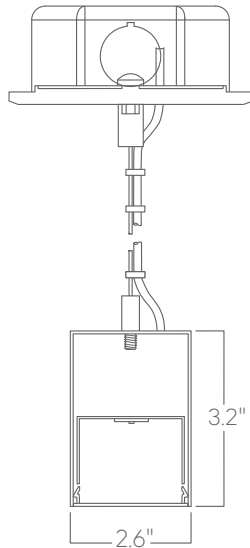

**Aircraft cable
5" canopy**

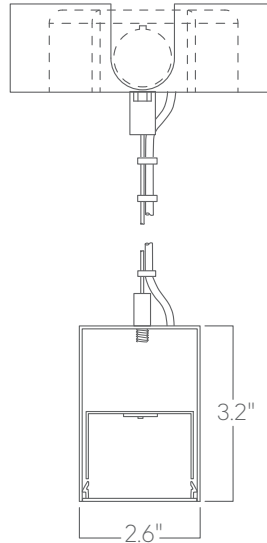

**Aircraft cable
Conduit canopy
with knockouts**

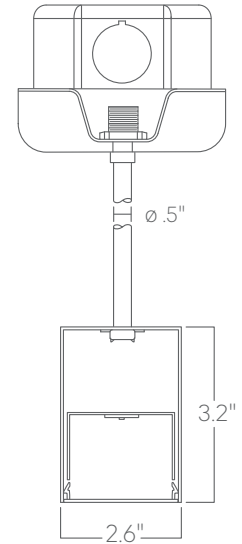

Pendant stem

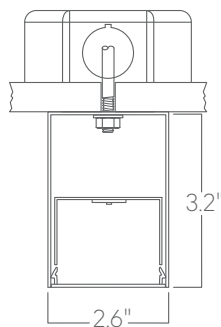

Surface mount

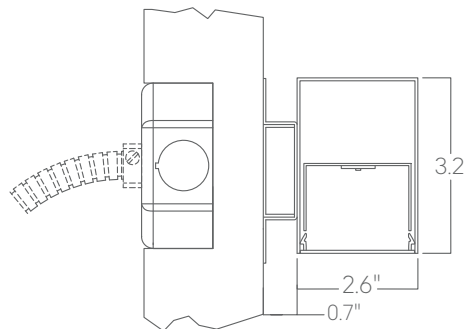

Wall mount